

n° 709

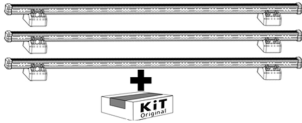

FIAT DOBLO (L1-L2/H1)

03/01>12/09



} 10 kg + xx Kg = kg max

Charge maximale admissible indiquée sur la boîte de kit. Ne pas dépasser la charge maximale autorisée par le constructeur du véhicule

Il Carico massimo ammissibile è indicato sulla scatola del kit. Non superare il carico massimo consentito dal costruttore del veicolo

Carga máxima admisible indicada en la caja de kit. No exceda la carga máxima permitida por el fabricante del vehículo.

Maximum allowable load indicated on the box of kit. Do not exceed the maximum load allowed by the vehicle manufacturer.

Maximal zulässige belastung angegeben auf der box der kit . Überschreiten sie nicht die maximale belastung durch den fahrzeughersteller zugelassen.

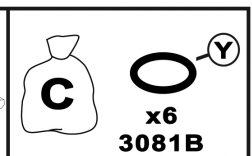
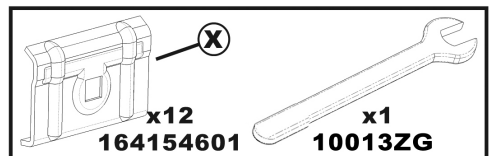
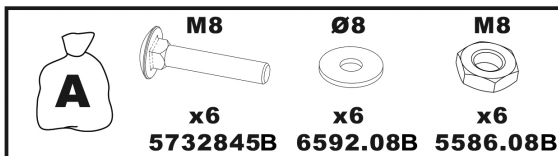
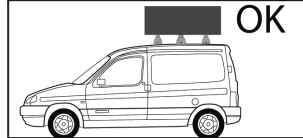
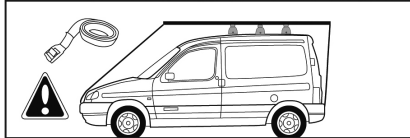
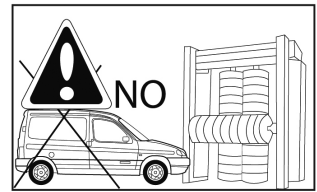
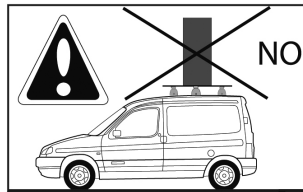
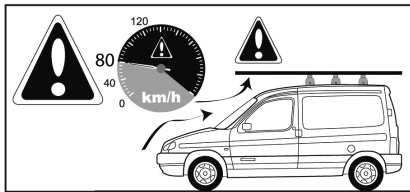

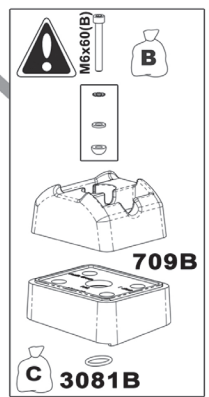
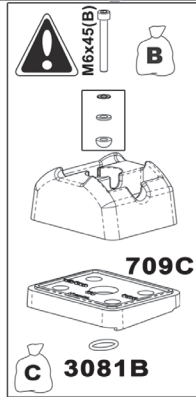
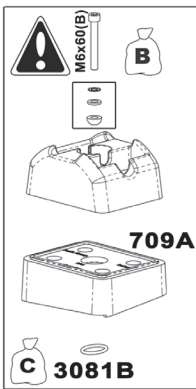
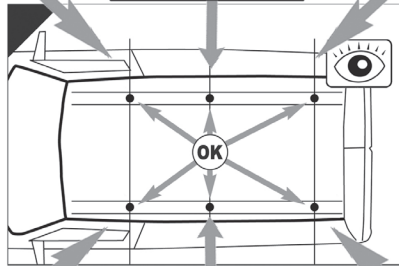
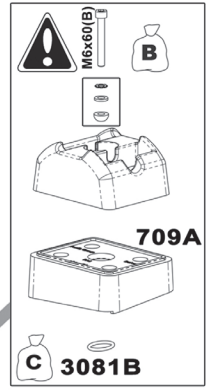
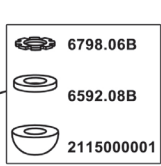
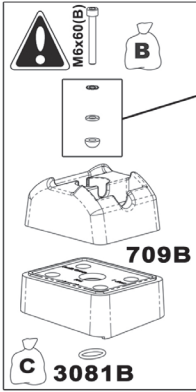
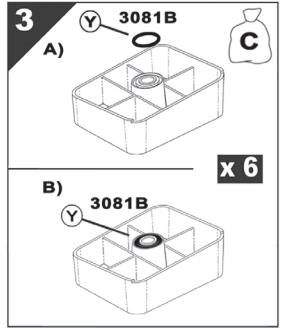
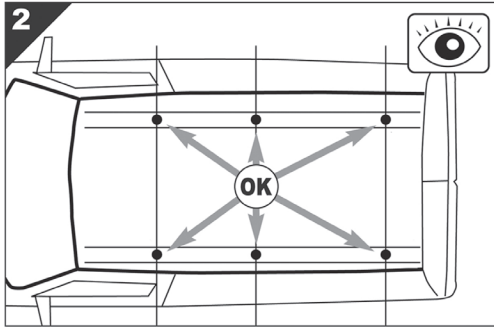

4

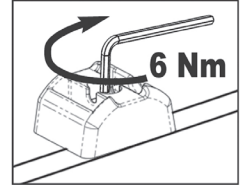
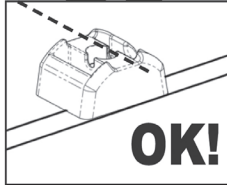
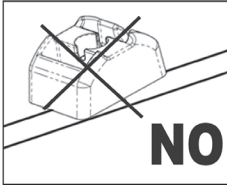
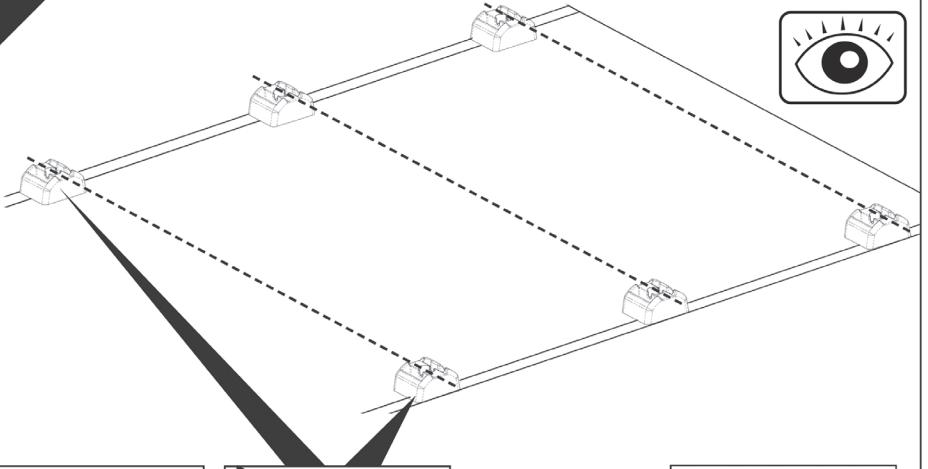

5

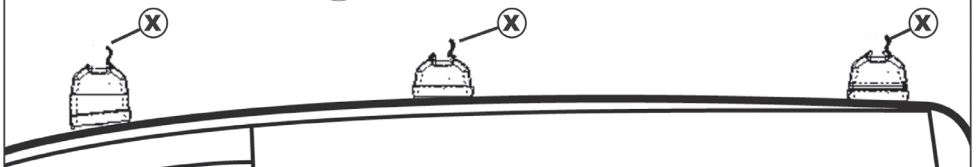
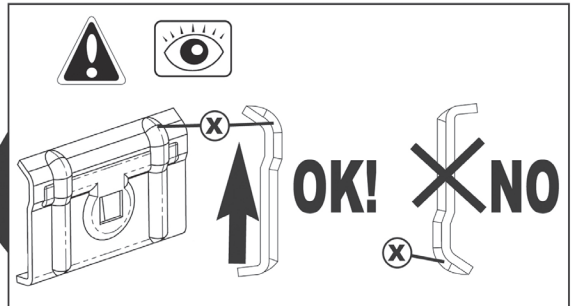
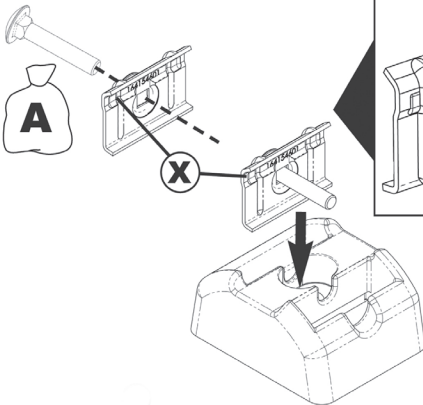

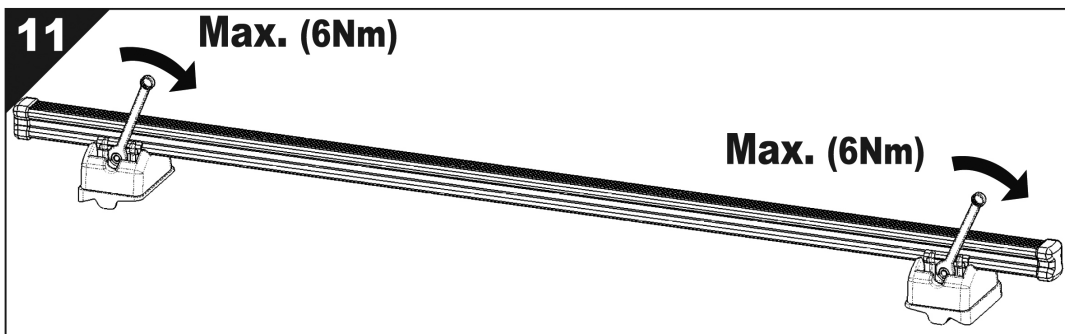
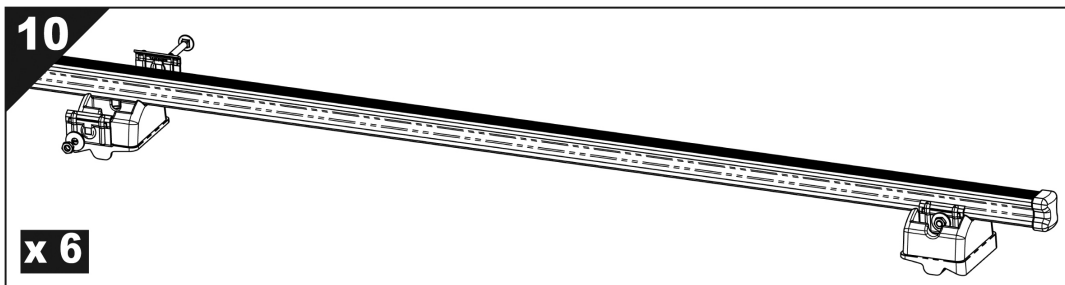
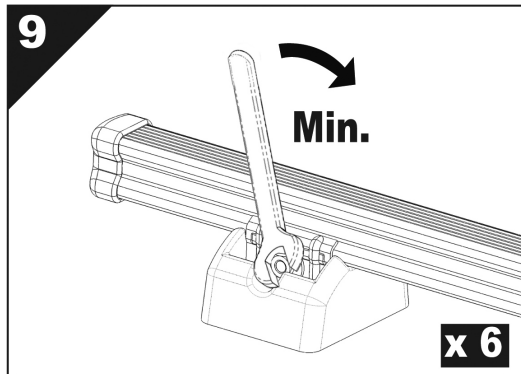
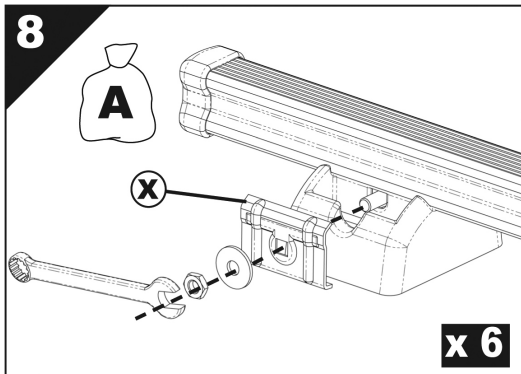
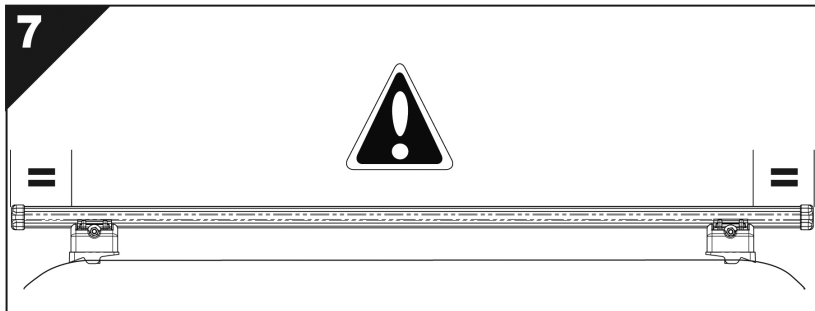
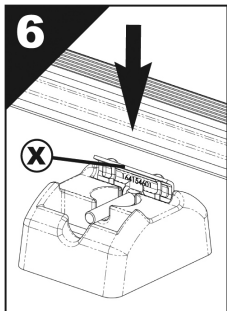

DG/MG - 04/12 - 11100709

AURILIS GROUP - 14/16 Rue Pierre Boulanger - 63100 CLERMONT FERRAND