

# TYPE D

## Ref.: 156123



ISO/PAS 11154



CITY CRASH TEST





# n° 123



**CITROEN C3**

**5**

**11/2009->**

 } **5 kg** +  = **75 kg max**

Ne pas dépasser la charge maximale des barres. Ne pas dépasser la charge maximale indiquée par le constructeur du véhicule

Non superare il carico massimo delle barre portatutto. Non superare il carico massimo indicato dal costruttore del veicolo

Carga máxima admisible indicada en la caja de las barras de techo. No exceda la carga máxima permitida por el fabricante del vehículo.

Maximum allowable load indicated on the box of roof bars. Do not exceed the maximum load allowed by the vehicle manufacturer.

Maximal zulässige belastung angegeben auf der box der dachreling. Überschreiten sie nicht die maximale belastung durch den fahrzeughersteller zugelassen.

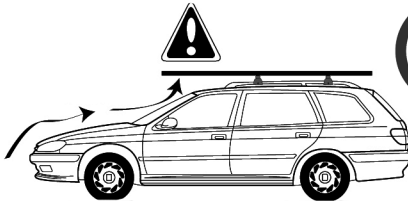

Max  
**80**  
Km/h

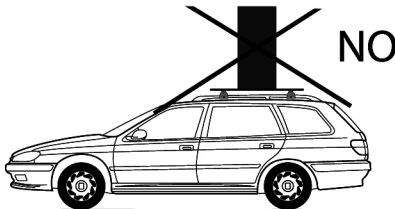
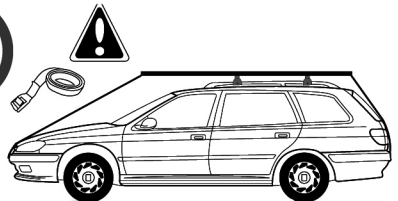

Max  
**130**  
Km/h

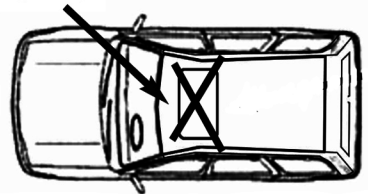
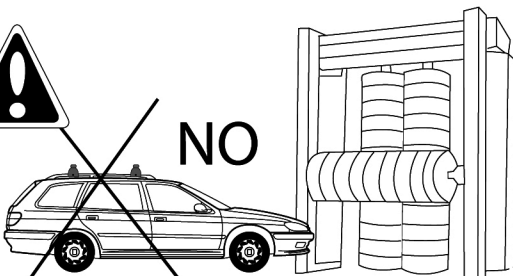
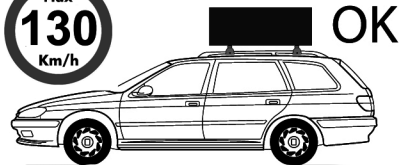

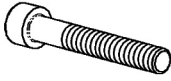
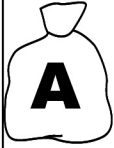

4762.616  
**x8**



6592.06  
**x8**



100005  
**x1**

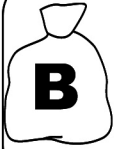

M6  
**x8**



6593.06  
**x8**



5012207  
**x4**



5012306  
**x4**

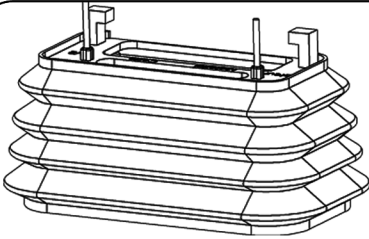

81003  
**x4**

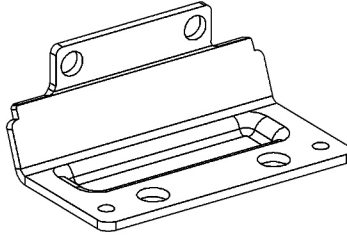

2512227  
**x4**

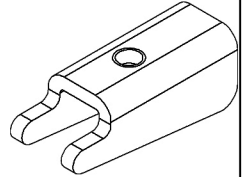

2512217  
**x8**

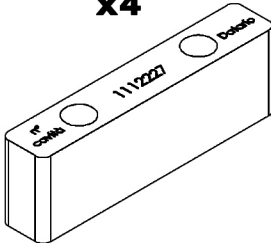

1212227  
**x2**

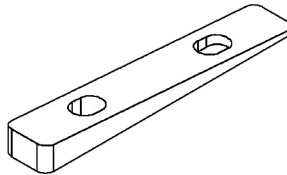

1512207  
**x2**

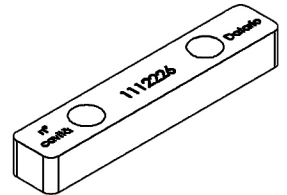

1112226  
**x2**

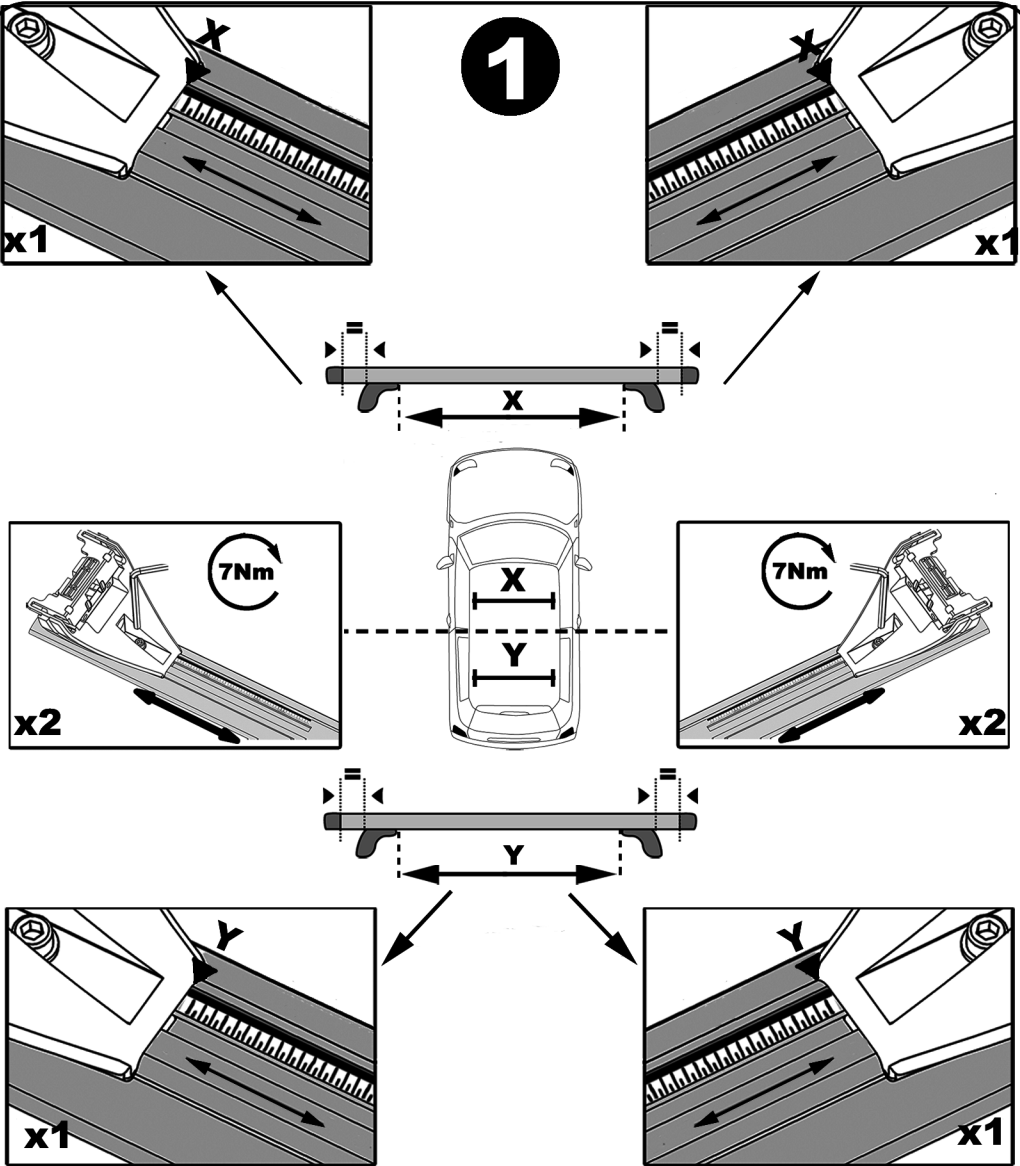

	X	Y
Citroen C3	70 cm	67 cm

2

x4

A)

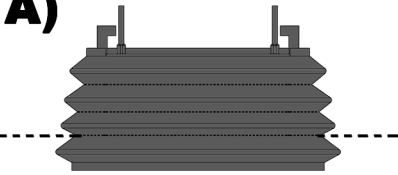

B)

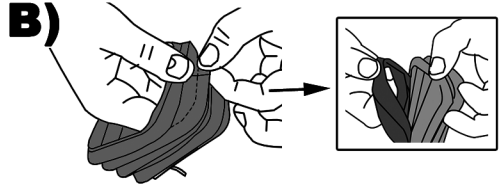

C)

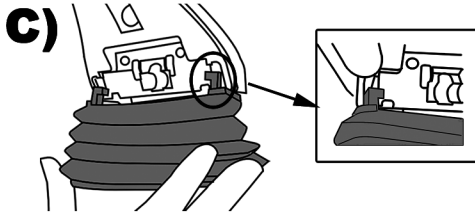

D)

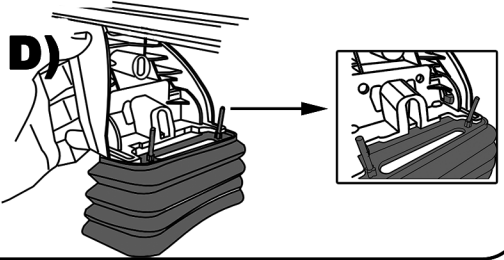

3

x4

A)

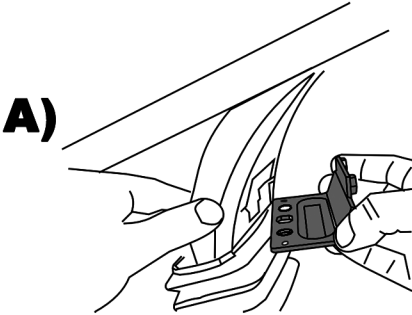

B)

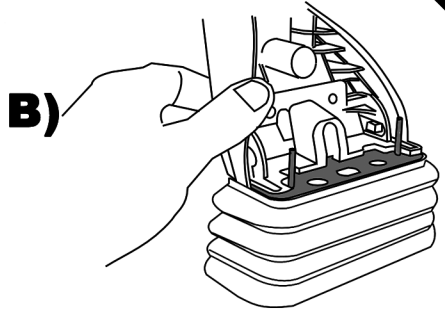

C)

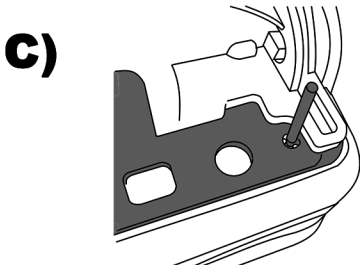

D)

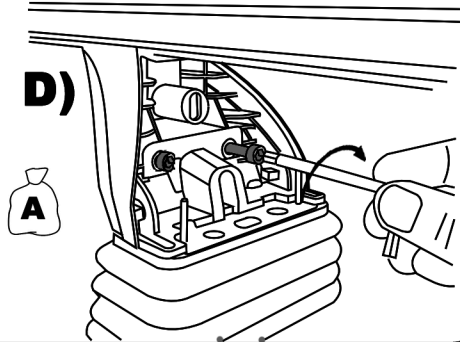

4

x2

A)

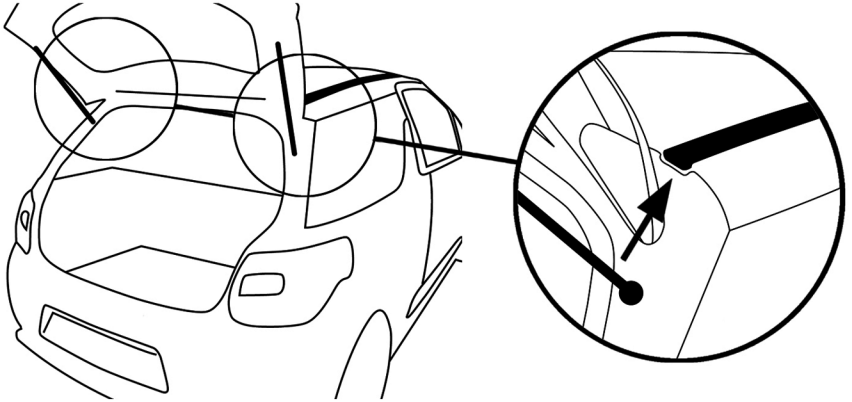

B)

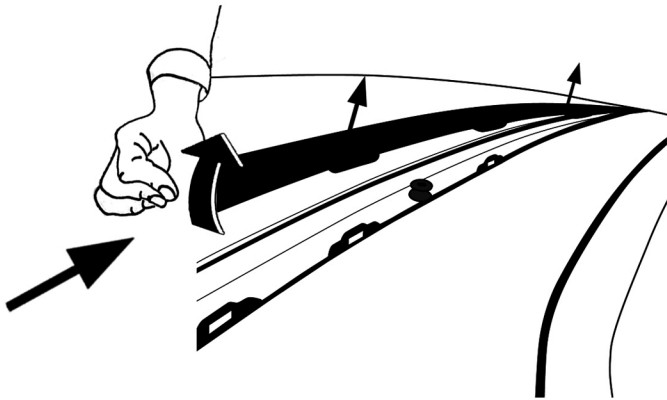

C)

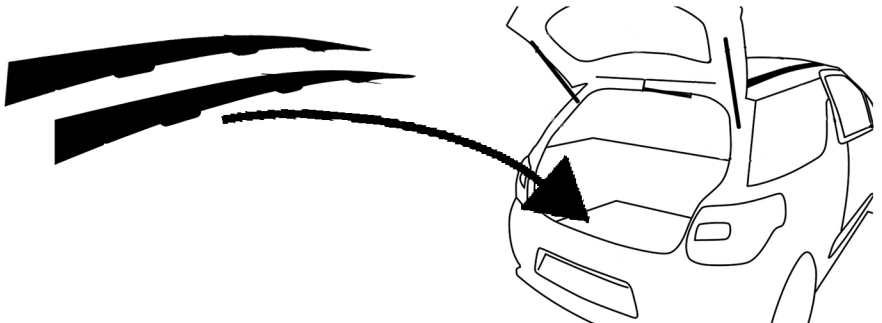

5

x2

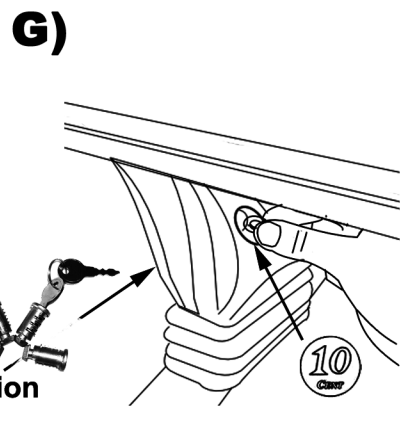
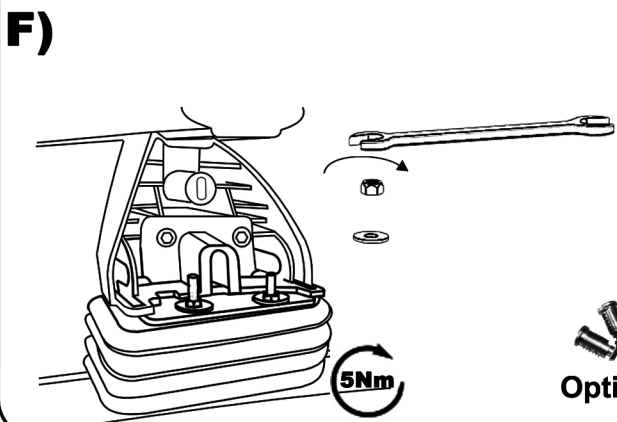
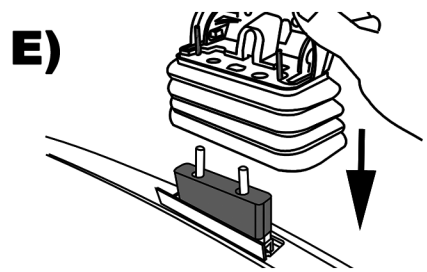
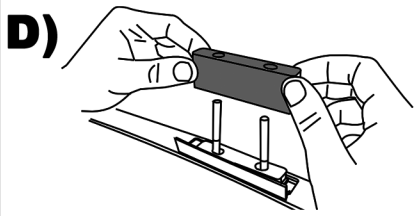
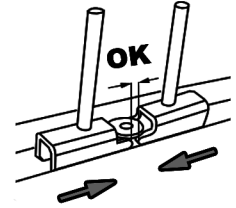
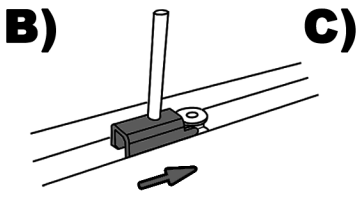
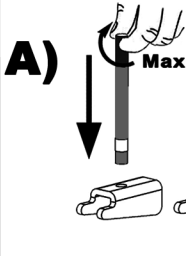
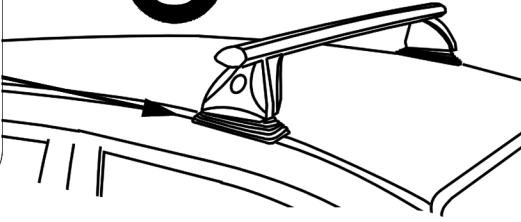
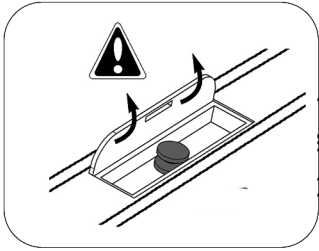

6

x2

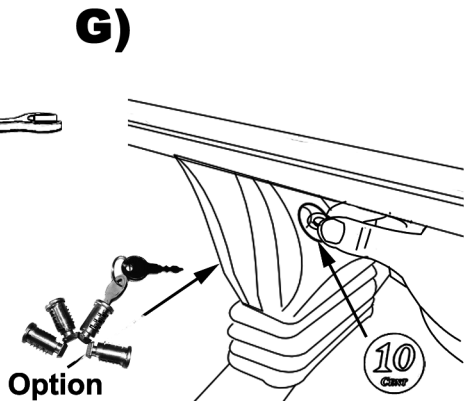
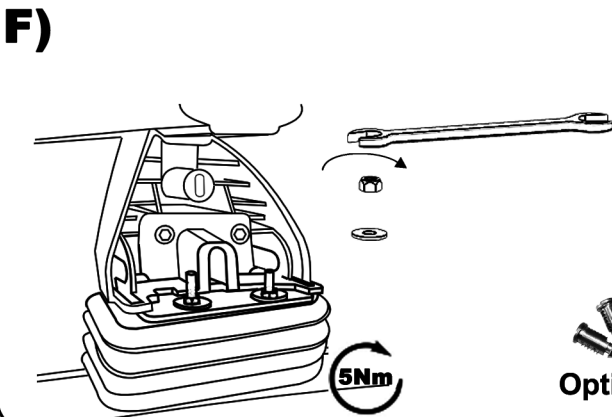
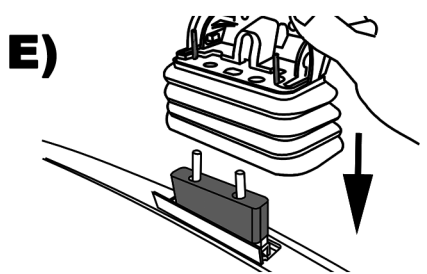
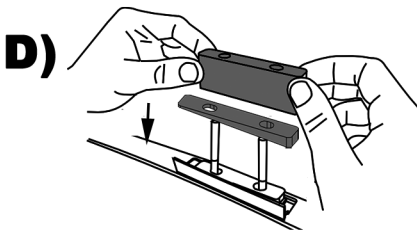
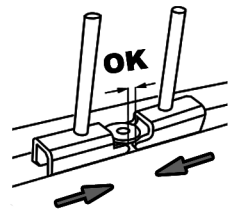
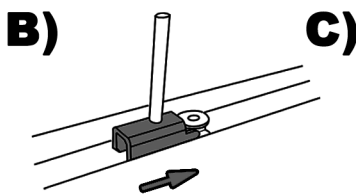
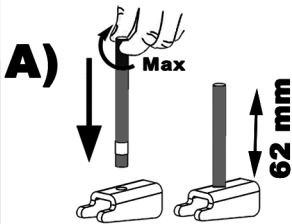
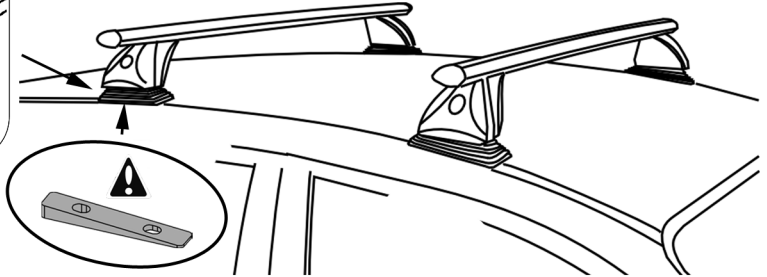
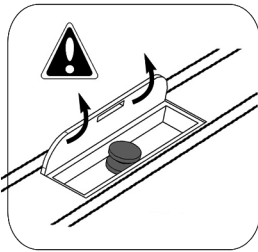

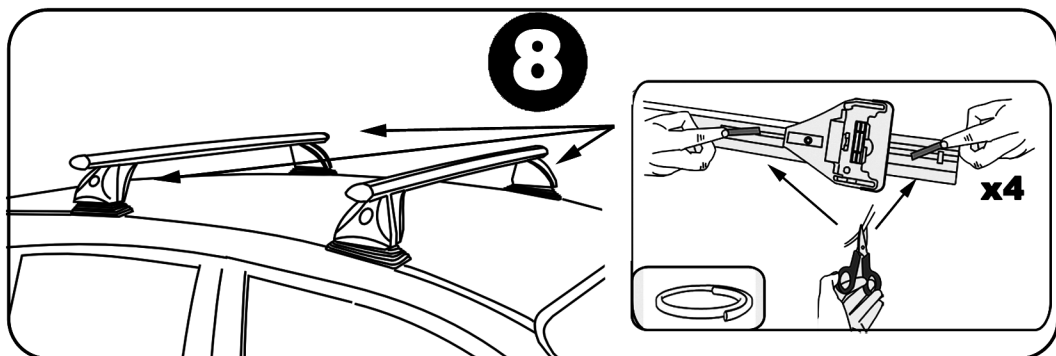
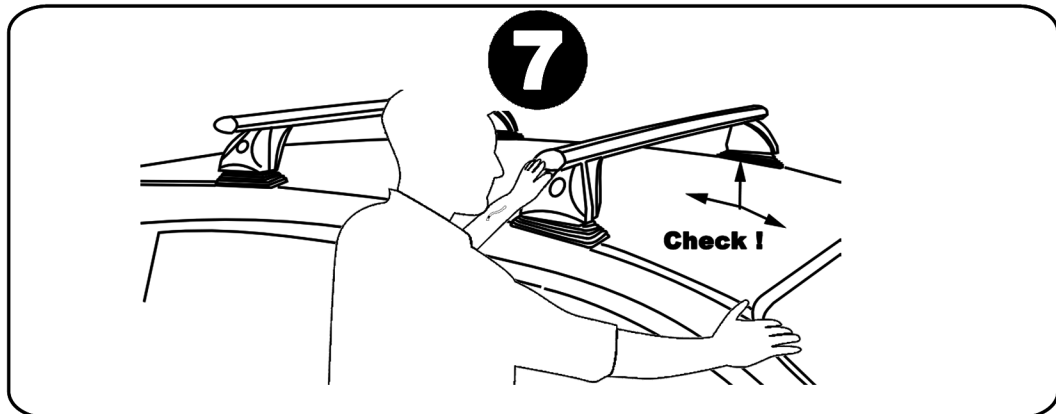

**FR:** Charge maxi 75 kg ne pas dépasser la charge maximale admissible par le constructeur du véhicule.  
**IT:** Carico massimo 75 kg non superare il carico massimo sul tetto indicato dal costruttore del veicolo  
**SP:** Capacidad máxima de carga 75 kg no exceda la máxima carga permitido por el fabricante del vehículo.  
**PT:** Capacidade máxima de carga 75 kg não exceder a carga máxima permitida pelo fabricante do veículo.  
**EN:** Maximum carrying capacity 75 kg do not exceed the maximum allowable load by the vehicle manufacturer.  
**DE:** Zulässige höchstlast 75 kg überschreiten sie nicht die maximale belastung zulässige vom fahrzeughersteller.  
**NL:** Maximaal toegestaan 75 kg neem niet meer de maximale belasting toegestane door de voertuigfabrikant.

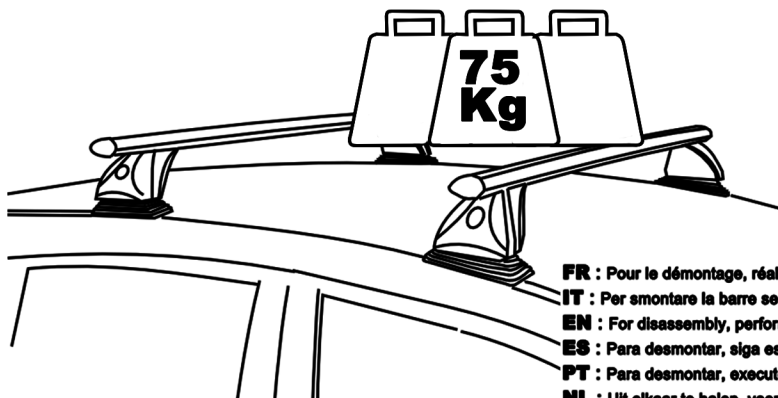

**FR :** Pour le démontage, réaliser à l'inversement ces étapes.  
**IT :** Per smontare la barre seguire le fasi al contrario .  
**EN :** For disassembly, perform these steps in reverse.  
**ES :** Para desmontar, siga estos pasos a la inversa.  
**PT :** Para desmontar, execute estas etapas em ordem inversa  
**NL :** Uit elkaar te halen, voert u deze stappen in omgekeerde.  
**DE :** Zu zerlegen, diese Schritte in umgekehrter