

# TYPE A

## Ref.: 156236



ISO/PAS 11154



CITY CRASH TEST



# n° 236

## Volkswagen Polo



5



10/2001 > 06/2009



**5 kg + xx Kg = 75 kg max**

Ne pas dépasser la charge maximale des barres. Ne pas dépasser la charge maximale indiquée par le constructeur du véhicule

Non superare il carico massimo delle barre portatutto. Non superare il carico massimo indicato dal costruttore del veicolo

Carga máxima admisible indicada en la caja de las barras de techo. No exceda la carga máxima permitida por el fabricante del vehículo.

Maximum allowable load indicated on the box of roof bars. Do not exceed the maximum load allowed by the vehicle manufacturer.

Maximal zulässige belastung angegeben auf der box der dachreling. Überschreiten sie nicht die maximale belastung durch den fahrzeughersteller zugelassen.

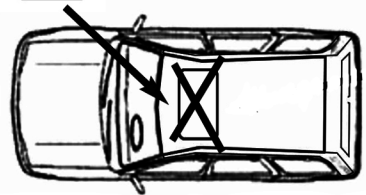
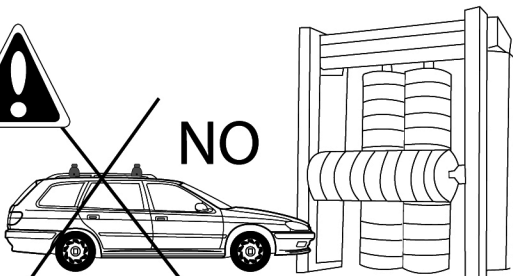
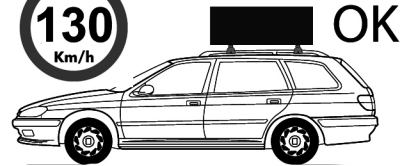
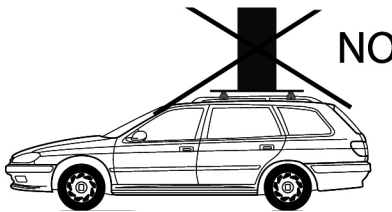
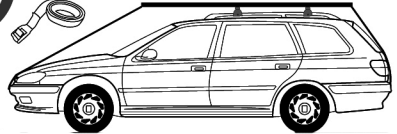
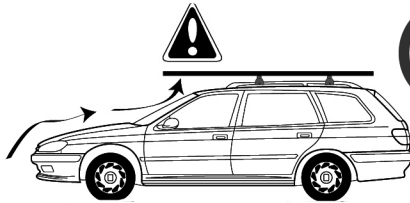

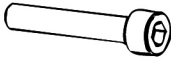
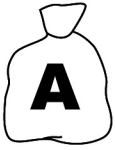

**M6X50 mm**  
**x4**

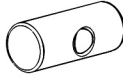

**162100001**  
**x4**



**659306**  
**x4**

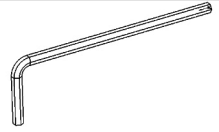

**100005**  
**x1**

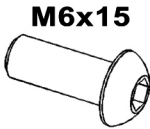

**M6x15**  
**7687617**  
**x2**

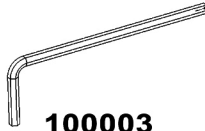

**100003**  
**x1**

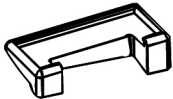

**x1**  
**1125001**

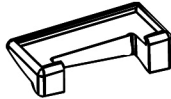

**x1**  
**1125002**

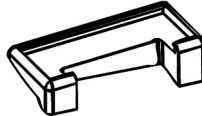

**x1**  
**1123103**

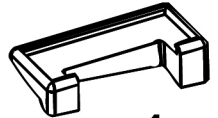

**x1**  
**1123104**

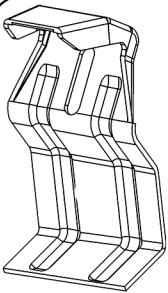

**x1**  
**231A**

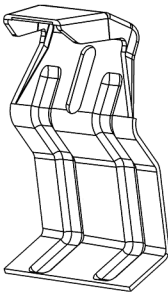

**x1**  
**231B**

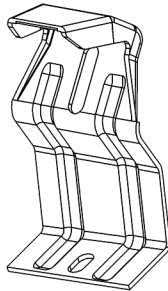

**x1**  
**231C**

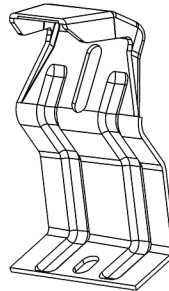

**x1**  
**231D**

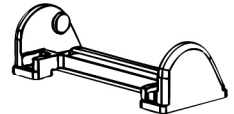

**x4**  
**214800001**

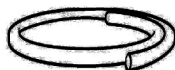

**x4**  
**3520207**

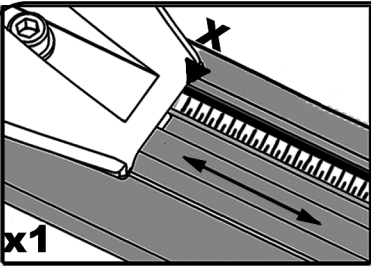

**1**

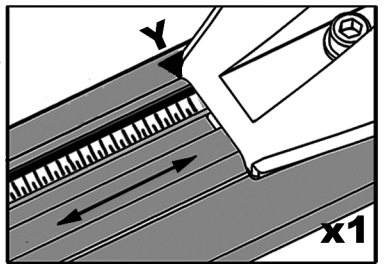
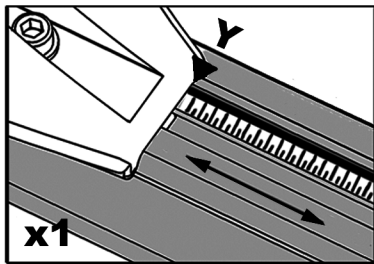
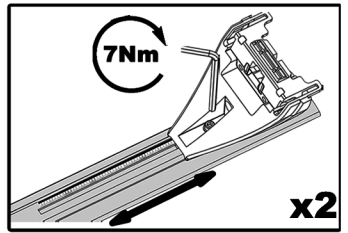
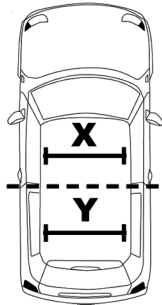
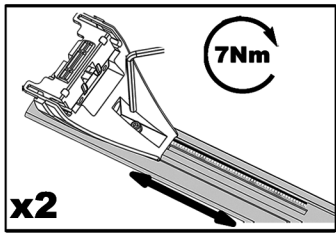
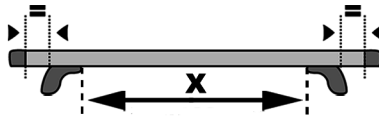
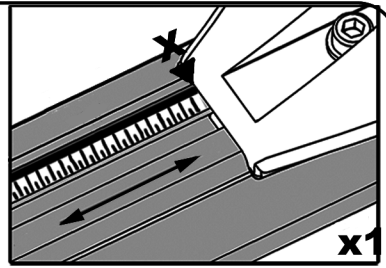

	X	Y
Volkswagen Polo IV	86 cm	80 cm

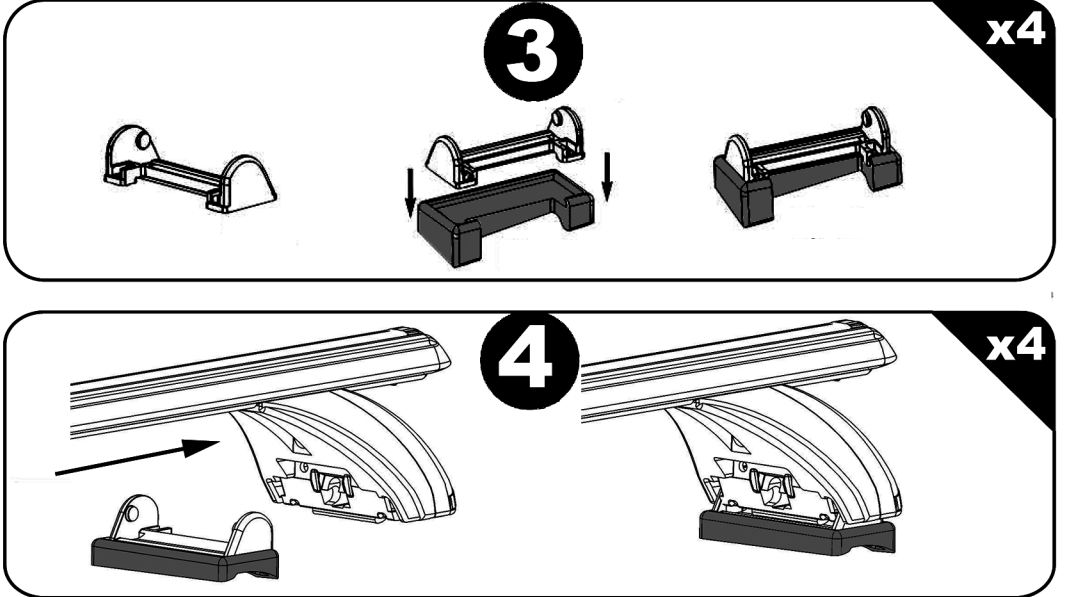
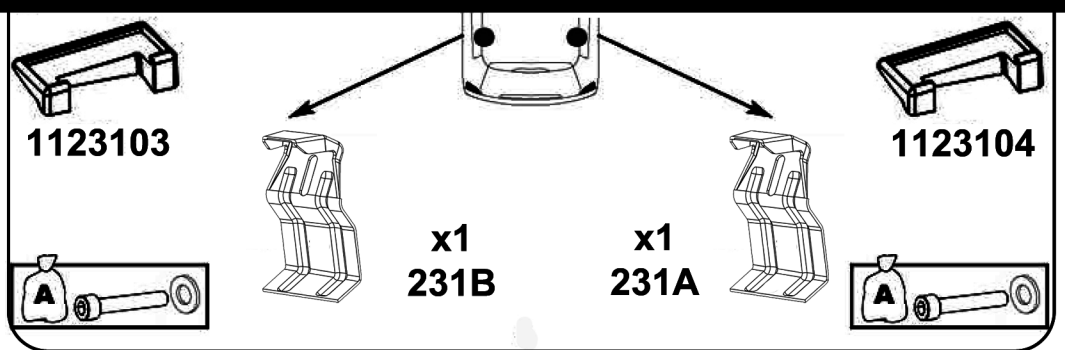
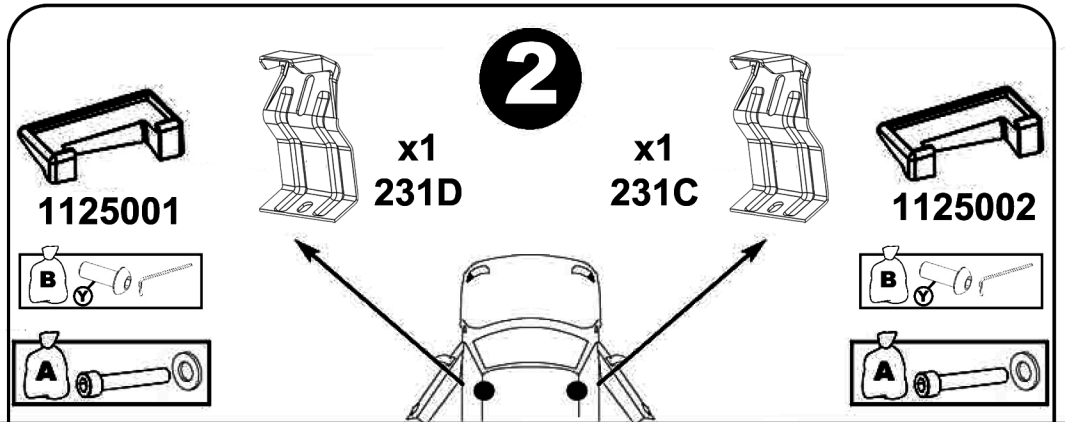

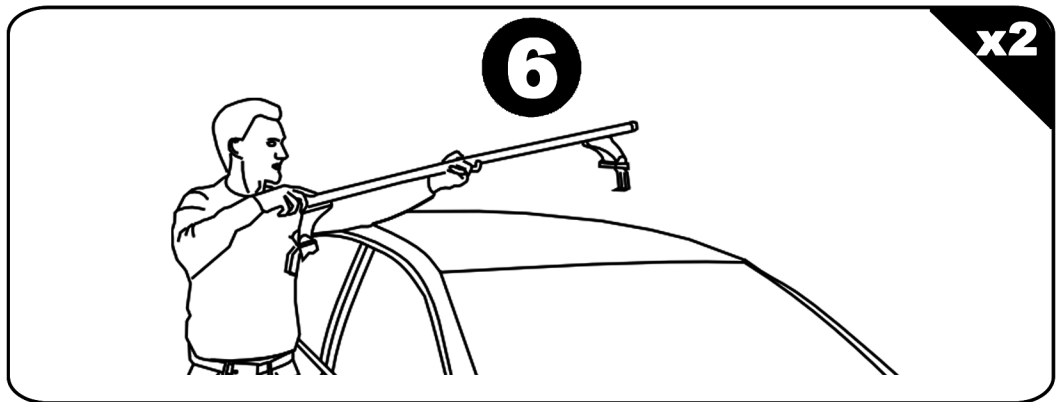
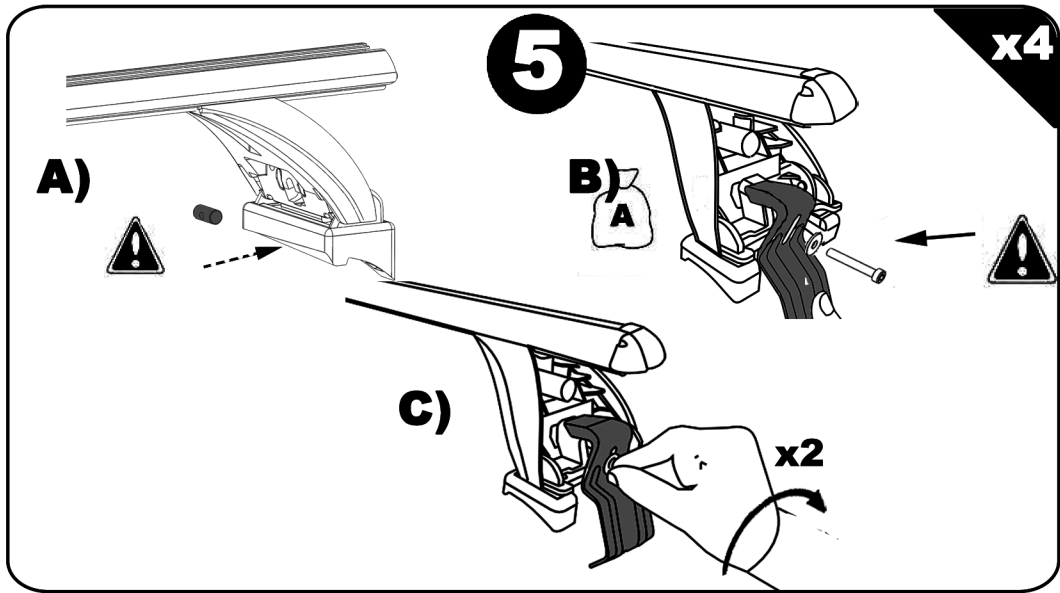

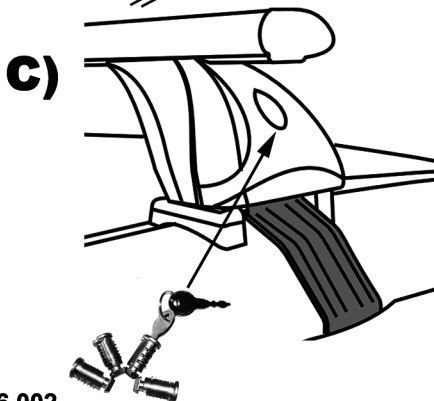
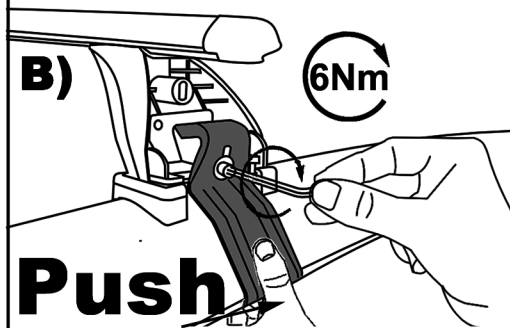
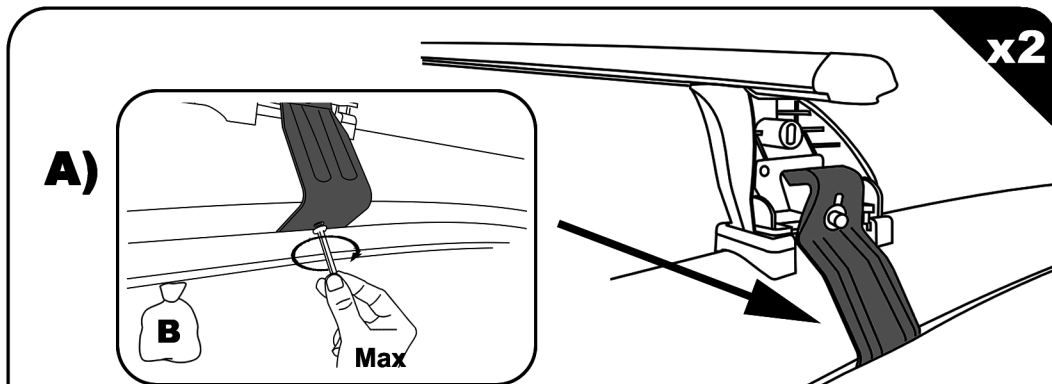
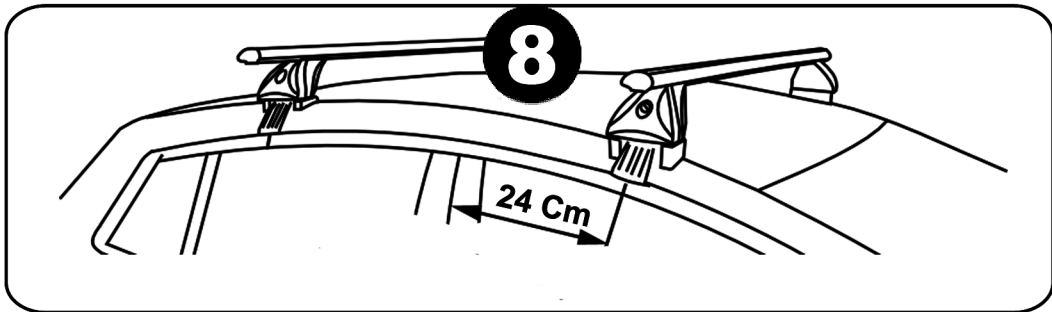

OPTION 156.002

**F** Serrer alternativement chaque côté  
**E** Alternare il serraggio delle viti  
**I** Serrare alternativamente  
**P** Aperte alternadamente  
**GB** Tighten alternately  
**D** Die Schrauben abwechselnd anziehen

**NL** Afwisselend aan de linker en de rechterkant aandraaien  
**S** Dra åt växelvis  
**FIN** Kierrä vuorotellen  
**EST** Pinguldage vaheldumisi  
**LAT** Pievelciēt pamāšus  
**LIT** Uzsukinėkite pakaitomis  
**PL** Sruby dokrecaj naprzemiennie

**CZ** Pokretla bagaznika dokrecaj dokrecaj naprzemiennie  
**SK** Dotahujte striedavo  
**SLO** Privijajte izmenično  
**HR** Naizmjenično zategnite  
**HU** Egymástól függetlenül szorítandó  
**TR** Dönüsümlü sikin

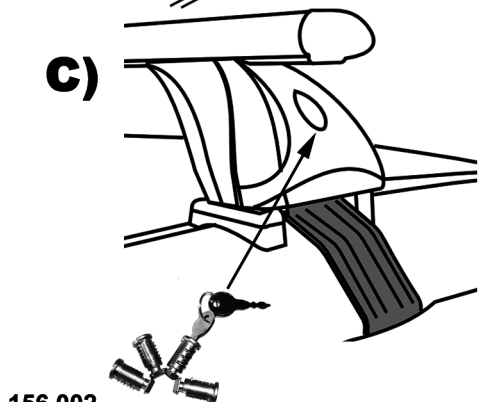
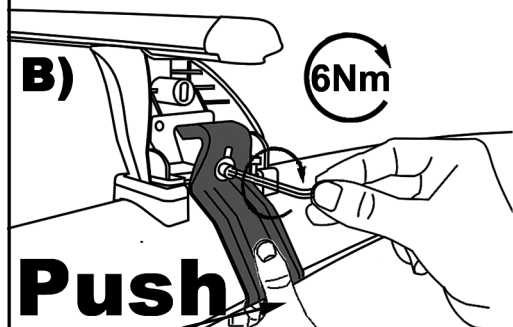
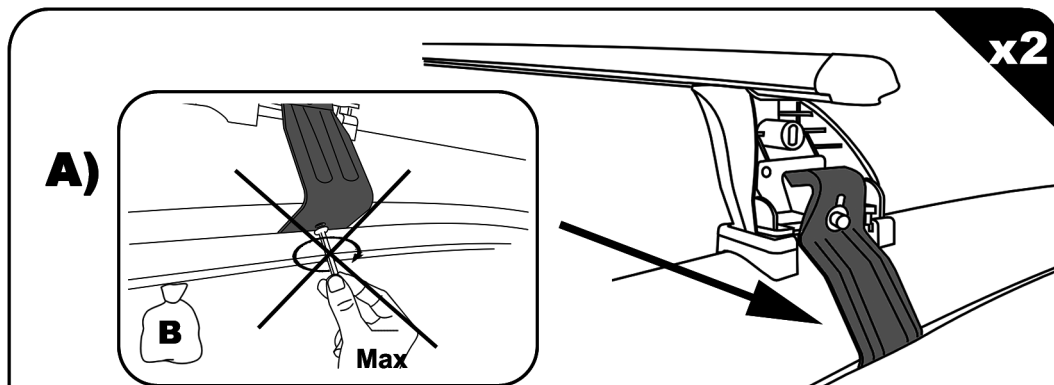
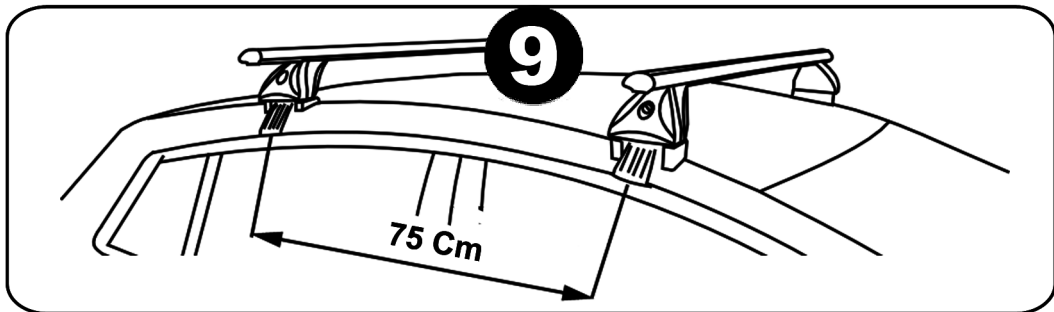

**OPTION 156.002**

**F** Serrer alternativement chaque côté  
**E** Alternare il serraggio delle viti  
**I** Serrare alternativamente  
**P** Aperte alternadamente  
**GB** Tighten alternately  
**D** Die Schrauben abwechselnd anziehen

**NL** Afwisselend aan de linker en de rechterkant aandraaien  
**S** Dra át växelvis  
**FIN** Kierrä vuorotellen  
**EST** Pinguldage vaheldumisi  
**LAT** Pievelciēt pamāšus  
**LIT** Uzsukinėkite pakaitomis  
**PL** Sruby dokreczej naprzemiennie

**CZ** Pokretla bagaznika dokrecaj dokrecaj naprzemiennie  
**SK** Dotahujte striedavo  
**SLO** Privijajte izmenično  
**HR** Naizmjenično zategnite  
**HU** Egymástól függetlenül szorítandó  
**TR** Dönüşümlü sıkın

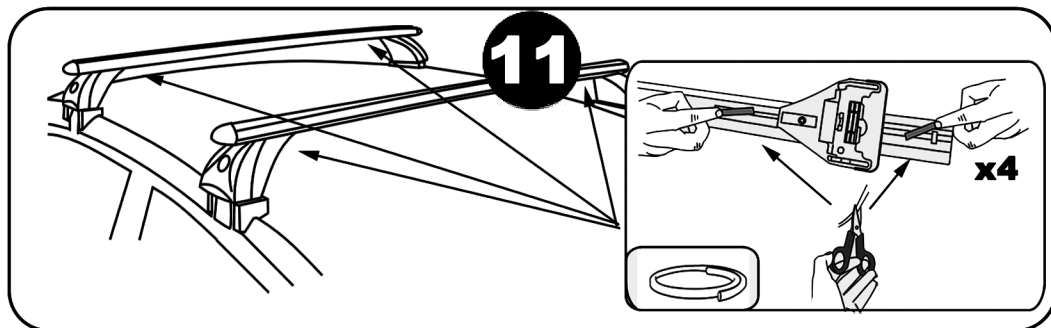
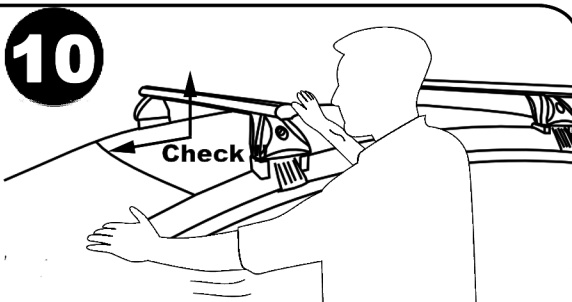
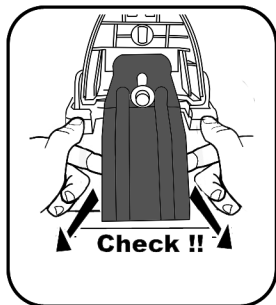

Démontage - Desmontaje - Smontaggio - Desmontagem - Disassembly - Demontage

