

TYPE A

Ref.: 156256



ISO/PAS 11154



CITY CRASH TEST





n° 256



Toyota Urban Cruiser

5

04/2009->

 } **5 kg** +  **xx Kg** = **75 kg max**

Ne pas dépasser la charge maximale des barres. Ne pas dépasser la charge maximale indiquée par le constructeur du véhicule

Non superare il carico massimo delle barre portatutto. Non superare il carico massimo indicato dal costruttore del veicolo

Carga máxima admisible indicada en la caja de las barras de techo. No exceda la carga máxima permitida por el fabricante del vehículo.

Maximum allowable load indicated on the box of roof bars. Do not exceed the maximum load allowed by the vehicle manufacturer.

Maximal zulässige belastung angegeben auf der box der dachreling. Überschreiten sie nicht die maximale belastung durch den fahrzeughersteller zugelassen.

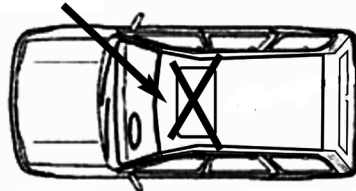
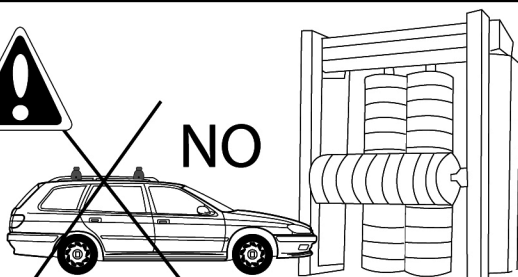
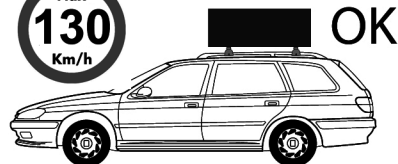
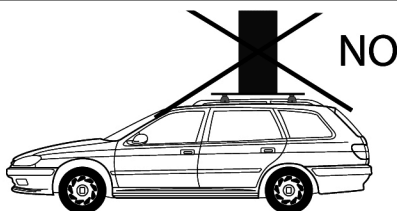
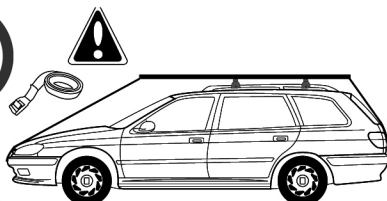
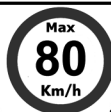
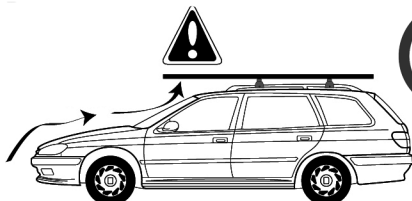

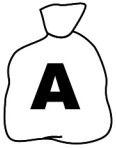

M6x50

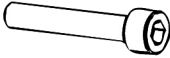

x4

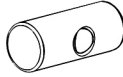

162100001

x4



659106

x4



100005

x1

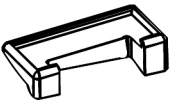

x1

1122501

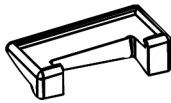

x1

1122502

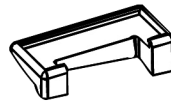

x1

1122503

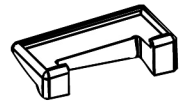

x1

1122504

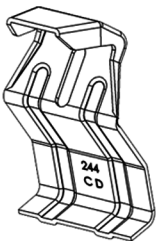

244CD

x4

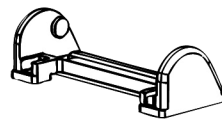

x4

214800001

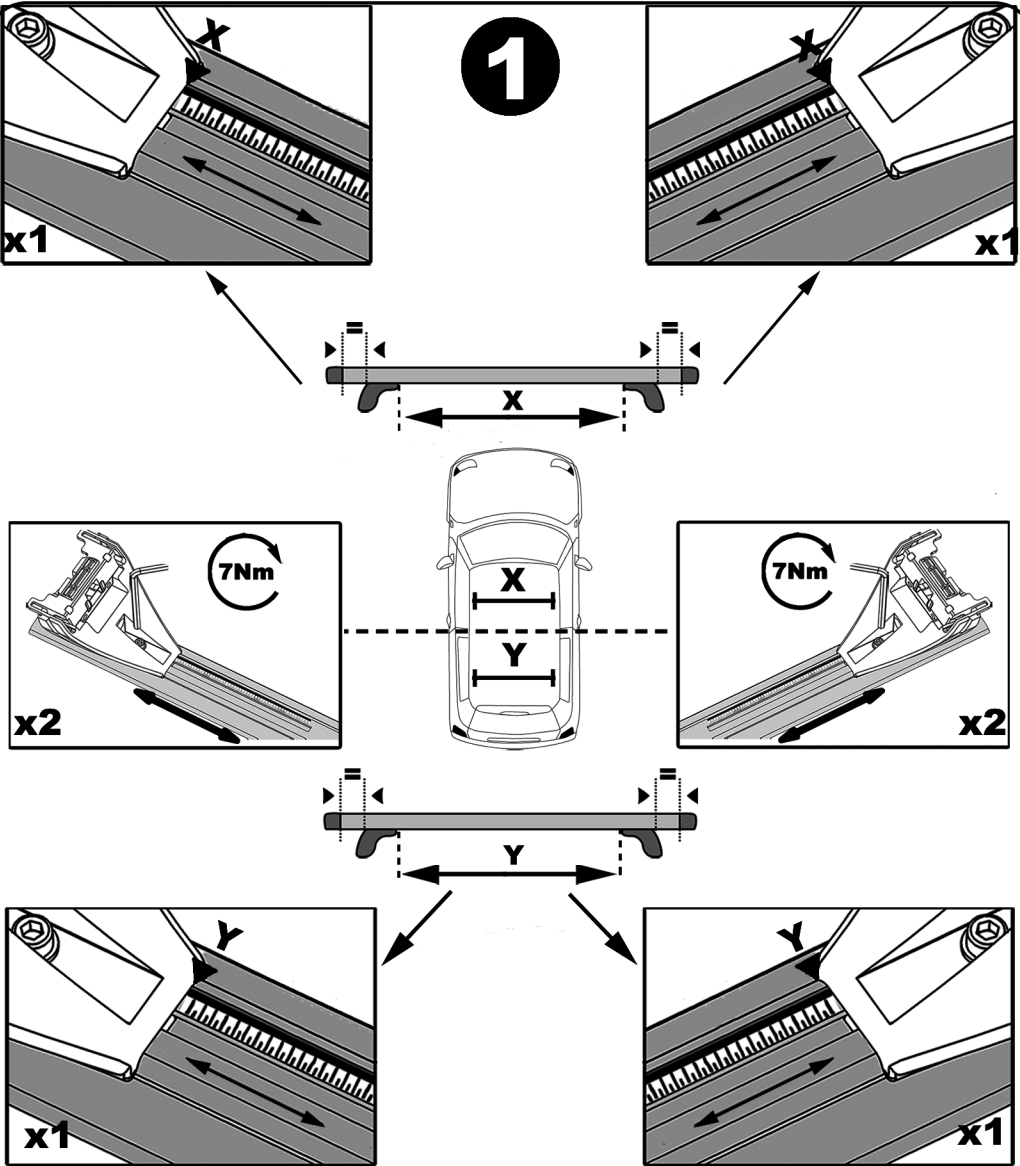

	X	Y
Toyota Urban Cruiser	83,5 cm	83 cm

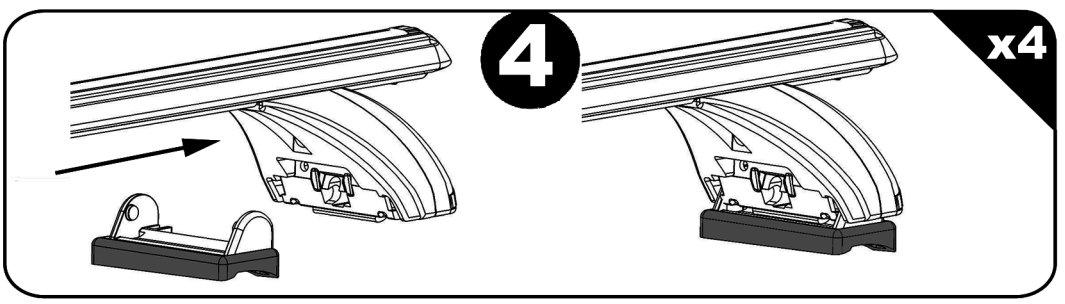
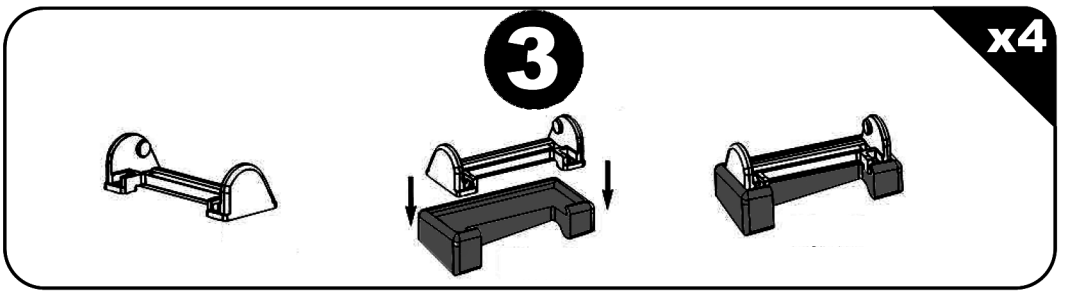
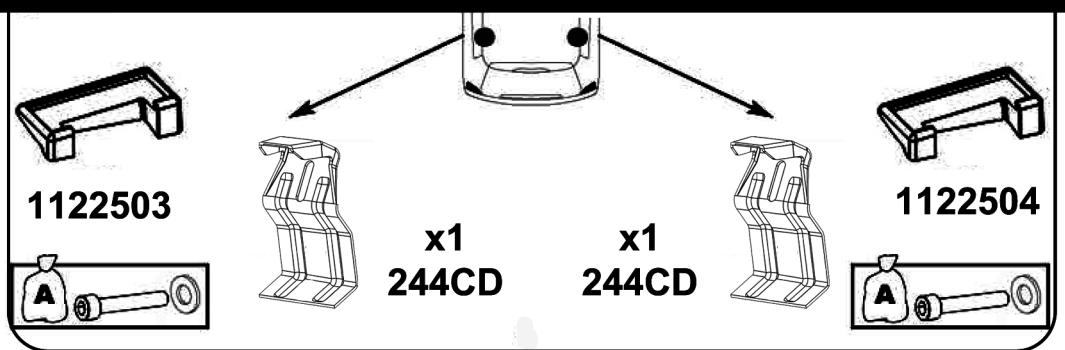
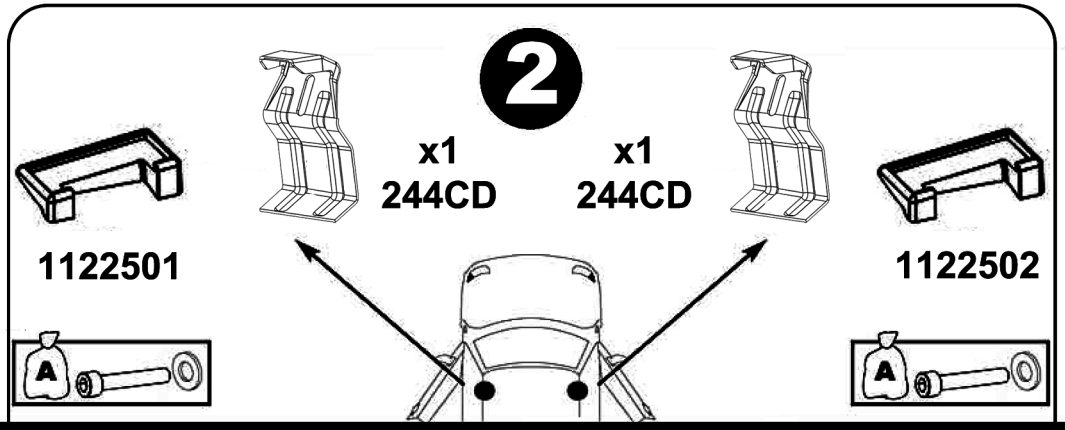

5

x4

A)

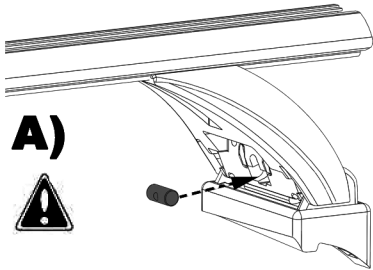

B)

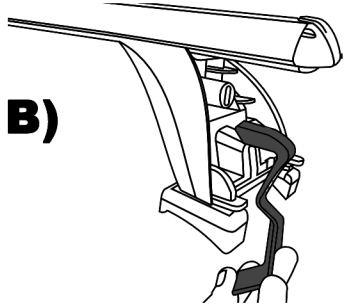

C)

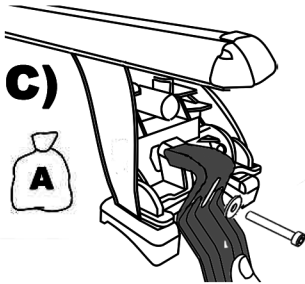

D)

x2

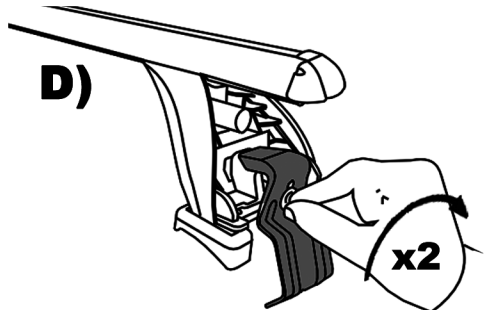

6

x2

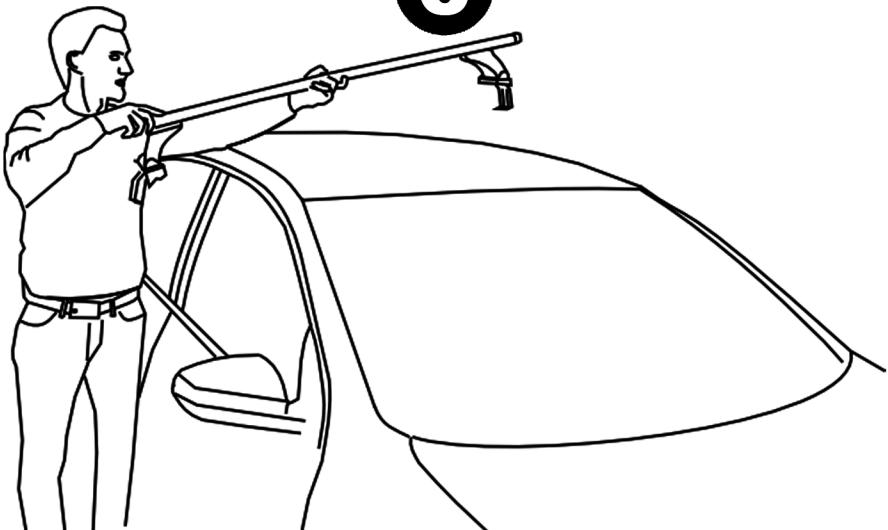

7

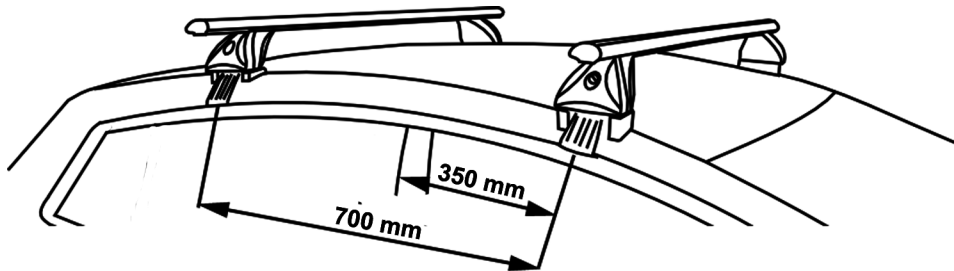

x4

A)

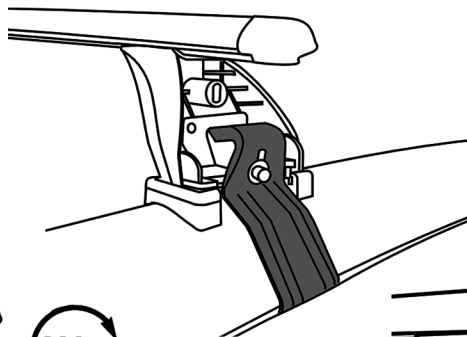

6Nm

B)

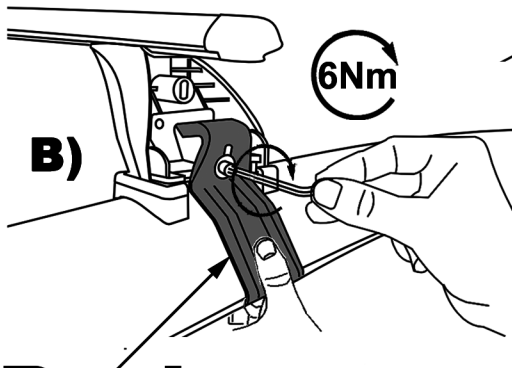

C)

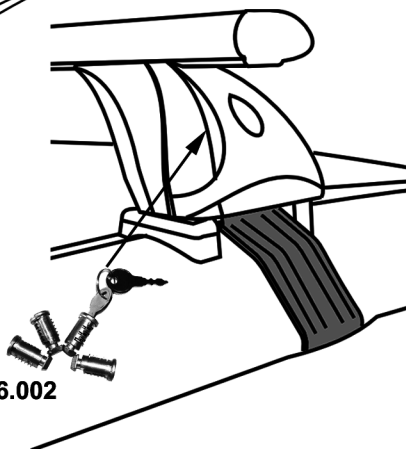

Push

OPTION 156.002

- F** Serrer alternativement chaque côté
E Alternare il serraggio delle viti
I Serrare alternativamente
P Aperte alternadamente
GB Tighten alternately
D Die Schrauben abwechselnd anziehen

- NL** Afwisselend aan de linker en de rechterkant aandraaien
S Dra åt växelvis
FIN Kierrä vuorotellen
EST Pinguldage vaheldumisi
LAT Pielvecliet pamāšus
LIT Uzsukinkite pakaitomis
PL Sruby dokrecaj naprzemiennie

- CZ** Pokretla bagaznika dokrecaj dokrecaj naprzemiennie
SK Dotahujte striedavo
SLO Privijajte izmenicno
HR Naizmjenicno zategnite
HU Egymástól függetlenül szorítandó
TR Dönüşümlü sıkın

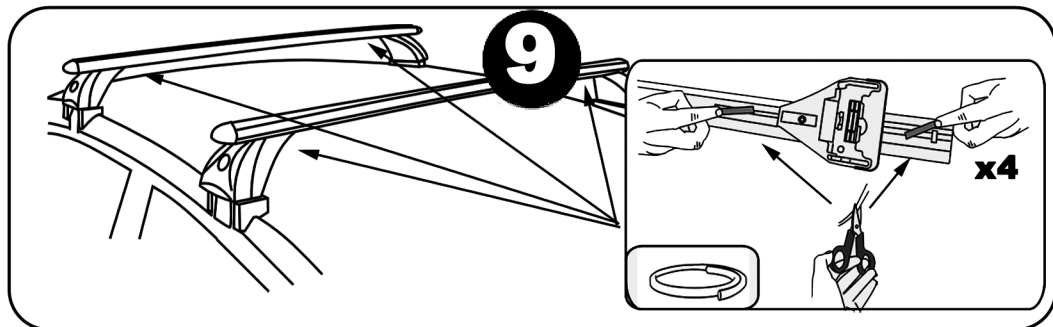
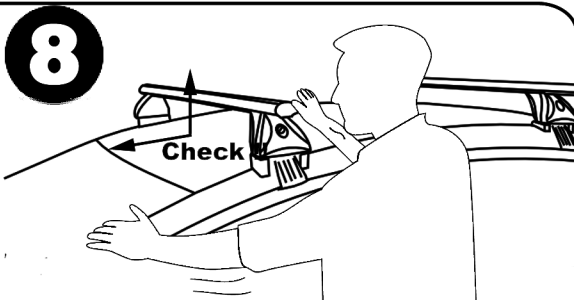
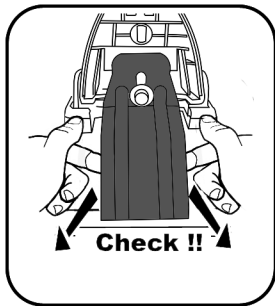

Démontage - Desmontaje - Smontaggio - Desmontagem - Disassembly - Demontage

