

# TYPE A

## Ref.: 156268



ISO/PAS 11154



CITY CRASH TEST



# n° 268



### Citroen C3 mkl

### 5

### 11/2001->08/2008



**5 kg + xx Kg = 75 kg max**

Ne pas dépasser la charge maximale des barres. Ne pas dépasser la charge maximale indiquée par le constructeur du véhicule

Non superare il carico massimo delle barre portatutto. Non superare il carico massimo indicato dal costruttore del veicolo

Carga máxima admisible indicada en la caja de las barras de techo. No exceda la carga máxima permitida por el fabricante del vehículo.

Maximum allowable load indicated on the box of roof bars. Do not exceed the maximum load allowed by the vehicle manufacturer.

Maximal zulässige belastung angegeben auf der box der dachreling. Überschreiten sie nicht die maximale belastung durch den fahrzeughersteller zugelassen.

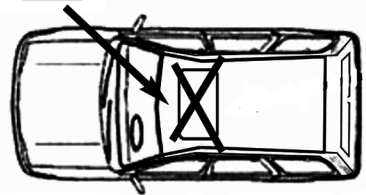
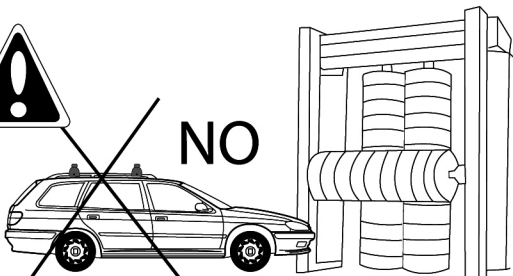
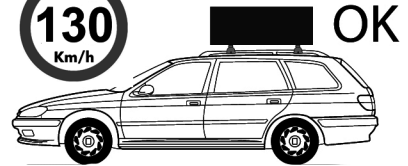
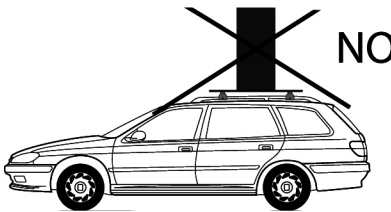
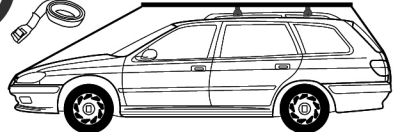
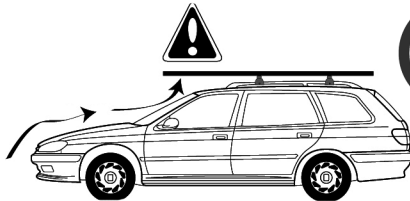

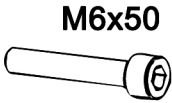
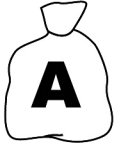

M6x50

4762.650  
x4

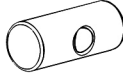

162100001  
x4



659106  
x4



100005  
x1

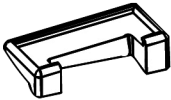

x1  
1120101

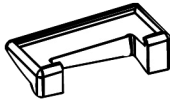

x1  
1120102

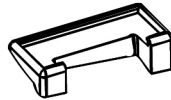

x1  
1120103

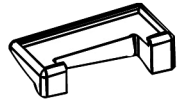

x1  
1120104

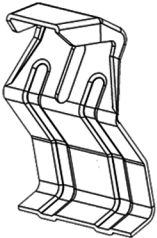

268A  
x2

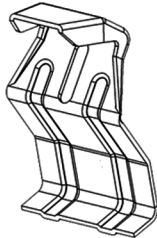

268B  
x2

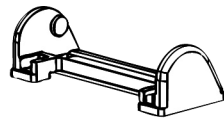

x4  
214800001



	X	Y
Citroen C3 mkl	84 cm	83 cm

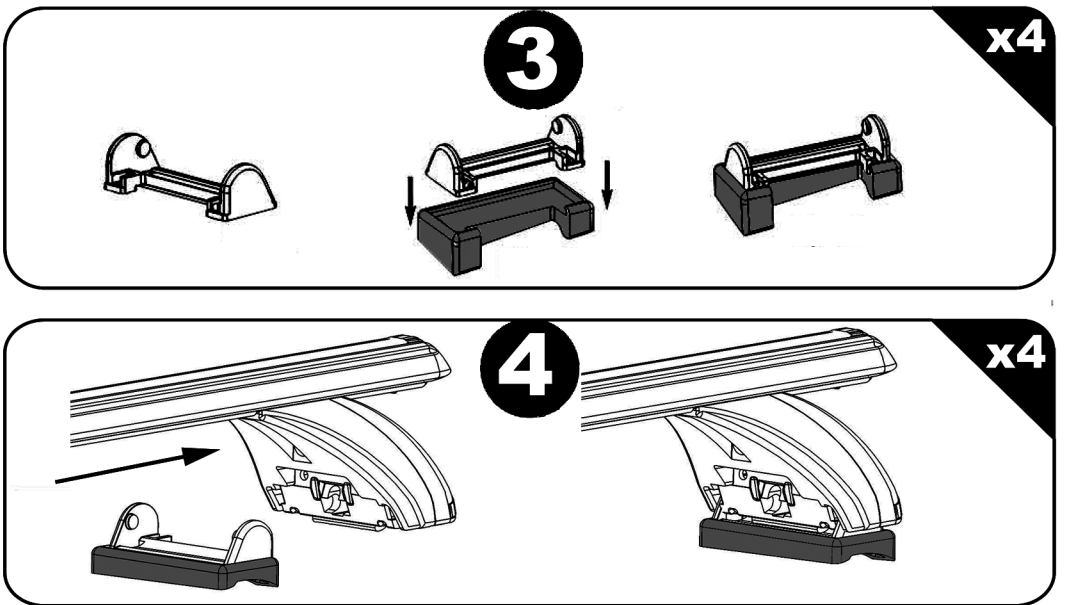
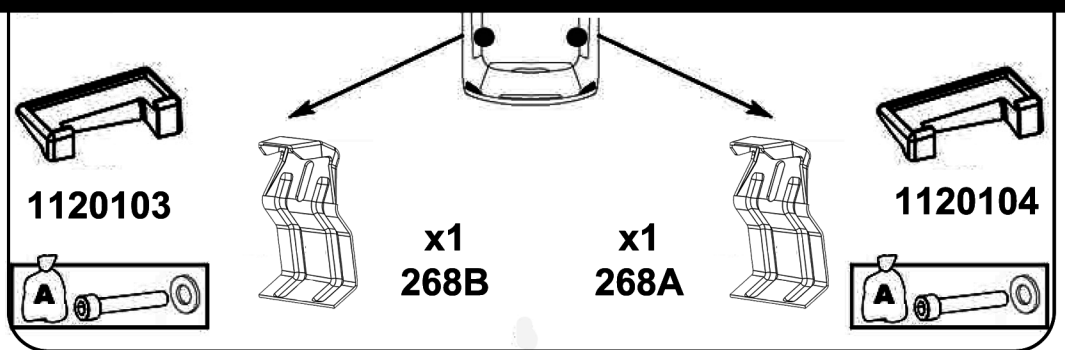
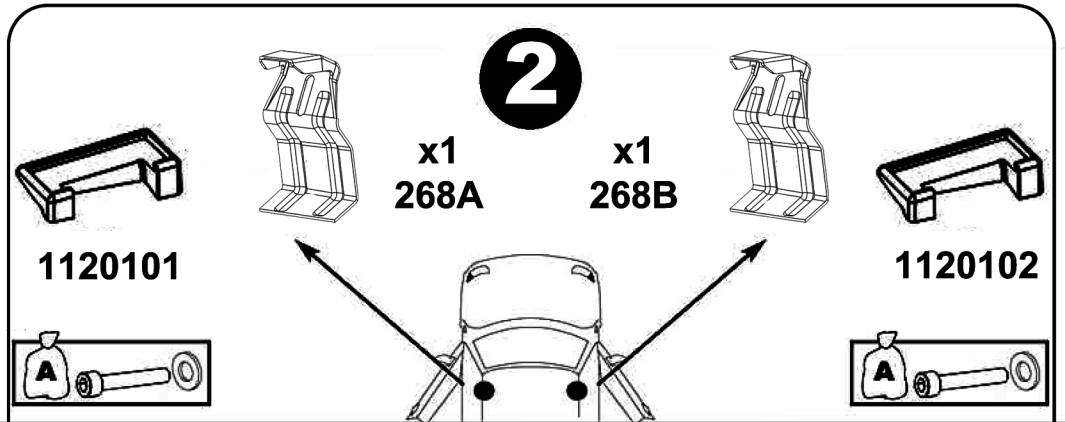

5

x4

A)

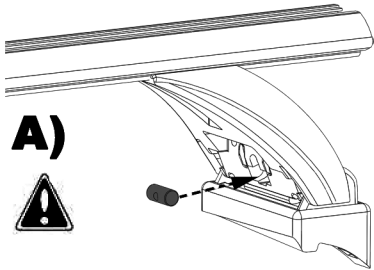

B)

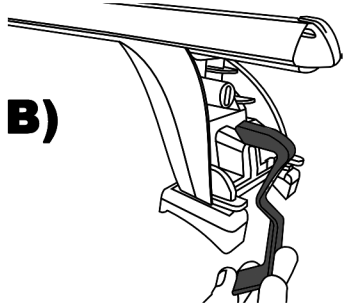

C)

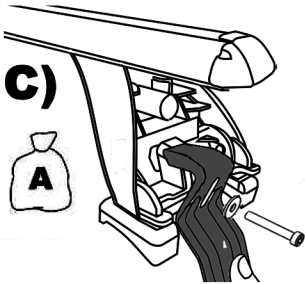

D)

x2

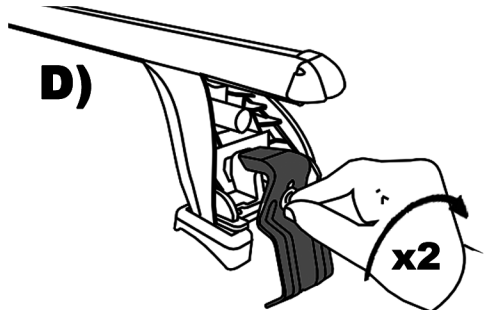

6

x2

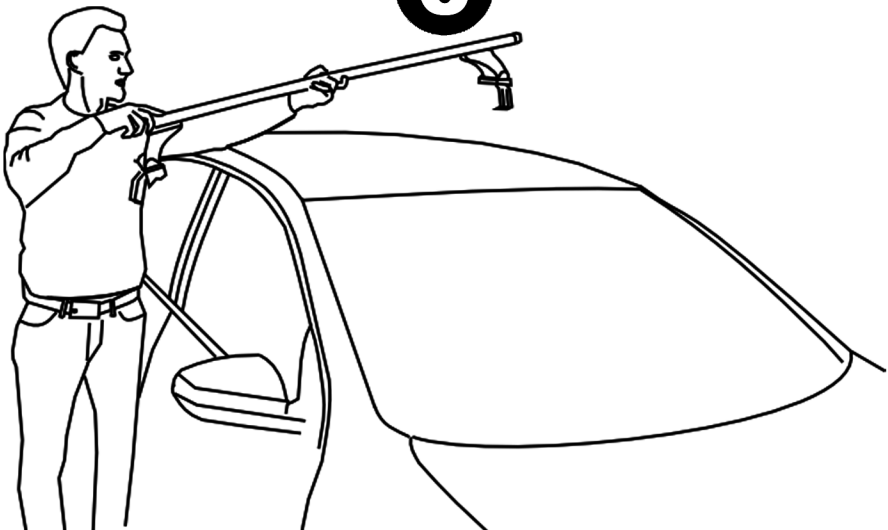

**7**

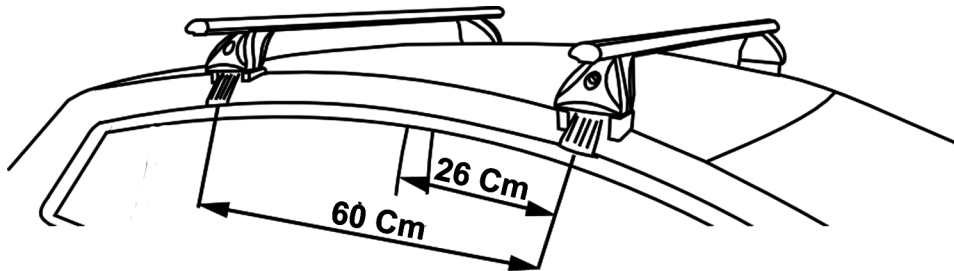

**x4**

**A)**

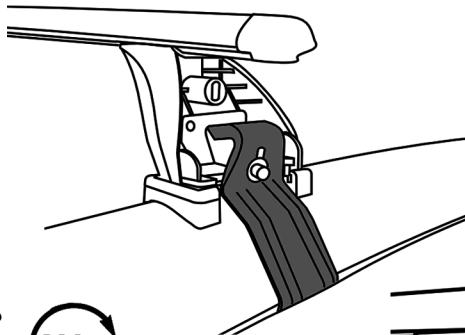

**6Nm**

**B)**

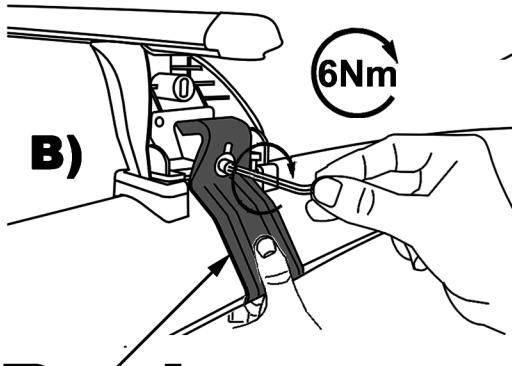

**C)**

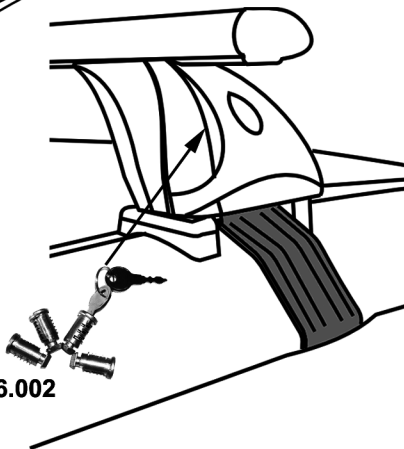

**Push**

**OPTION 156.002**

- F** Serrer alternativement chaque côté
- E** Alternare il serraggio delle viti
- I** Serrare alternativamente
- P** Aperte alternadamente
- GB** Tighten alternately
- D** Die Schrauben abwechselnd anziehen

- NL** Afwisselend aan de linker en de rechterkant aandraaien
- S** Dra åt växelvis
- FIN** Kierrä vuorotellen
- EST** Pinguldage vaheldumisi
- LAT** Pievelciēt pamāšus
- LIT** Uzsukinkite pakaitomis
- PL** Sruby dokrecaj naprzemiennie

- CZ** Pokretla bagaznika dokrecaj dokrecaj naprzemiennie
- SK** Dotahujte striedavo
- SLO** Privijajte izmenicno
- HR** Naizmjenicno zategnite
- HU** Egymástól függetlenül szorítandó
- TR** Dönüşümlü sıkın

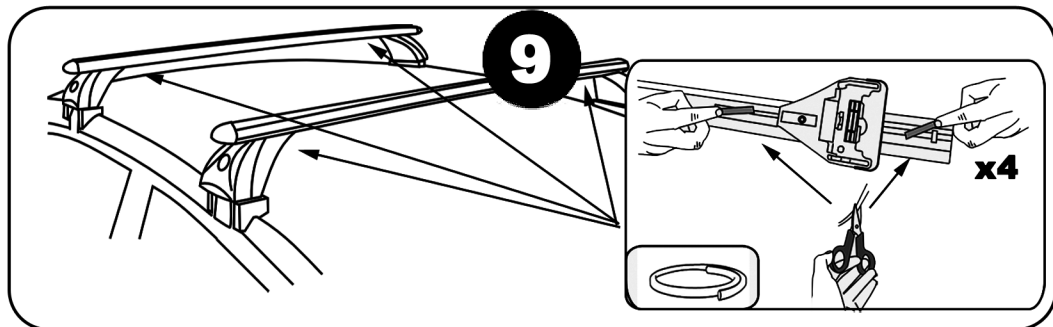
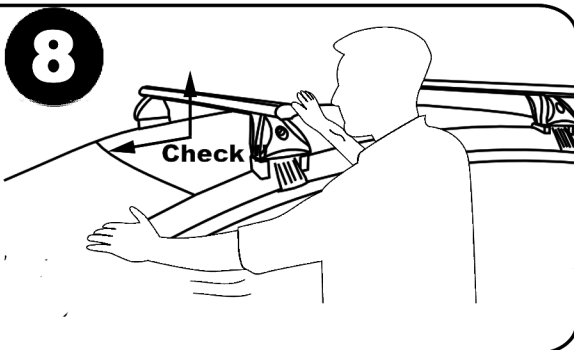
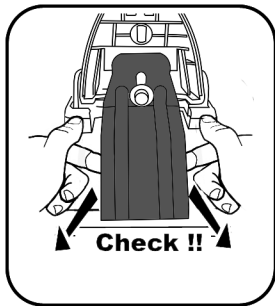

Démontage - Desmontaje - Smontaggio - Desmontagem - Disassembly - Demontage

