

TYPE A

Ref.: 156274



ISO/PAS 11154



CITY CRASH TEST



n° 274



Peugeot 208

5

07/2012->

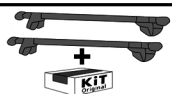

5 kg + xx Kg = 75 kg max

Ne pas dépasser la charge maximale des barres. Ne pas dépasser la charge maximale indiquée par le constructeur du véhicule

Non superare il carico massimo delle barre portatutto. Non superare il carico massimo indicato dal costruttore del veicolo

Carga máxima admisible indicada en la caja de las barras de techo. No exceda la carga máxima permitida por el fabricante del vehículo.

Maximum allowable load indicated on the box of roof bars. Do not exceed the maximum load allowed by the vehicle manufacturer.

Maximal zulässige belastung angegeben auf der box der dachreling. Überschreiten sie nicht die maximale belastung durch den fahrzeughersteller zugelassen.

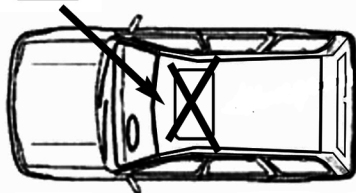
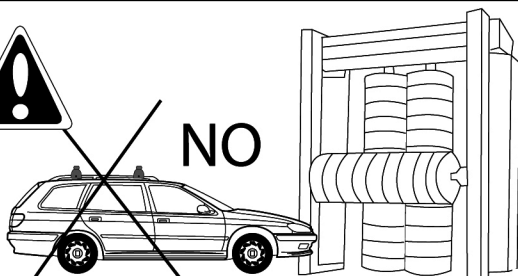
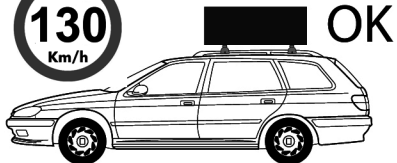
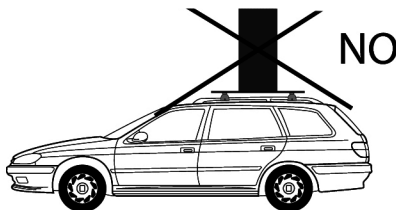
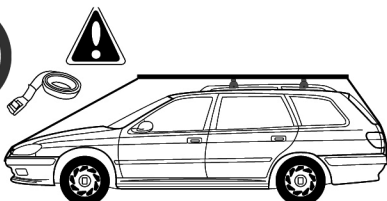
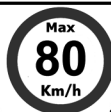
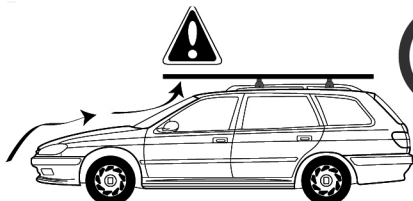

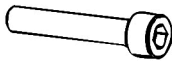
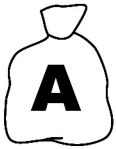

**M6x50
x4**

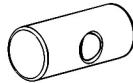

**162100001
x4**



**6591.06
x4**

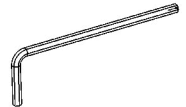

**100005
x1**

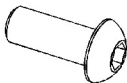
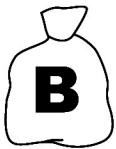

**M6x15
x4**



**100003
x1**

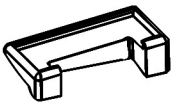

**x1
1127401**

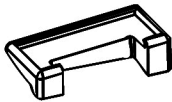

**x1
1127402**

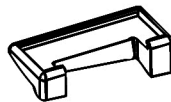

**x1
1122703**

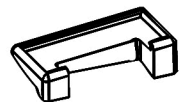

**x1
1122704**

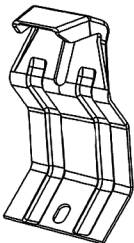

**x2
274CD**

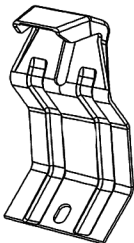

**x1
231C**

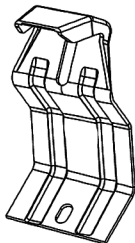

**x1
231D**

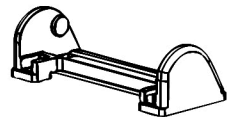

**x4
214800001**

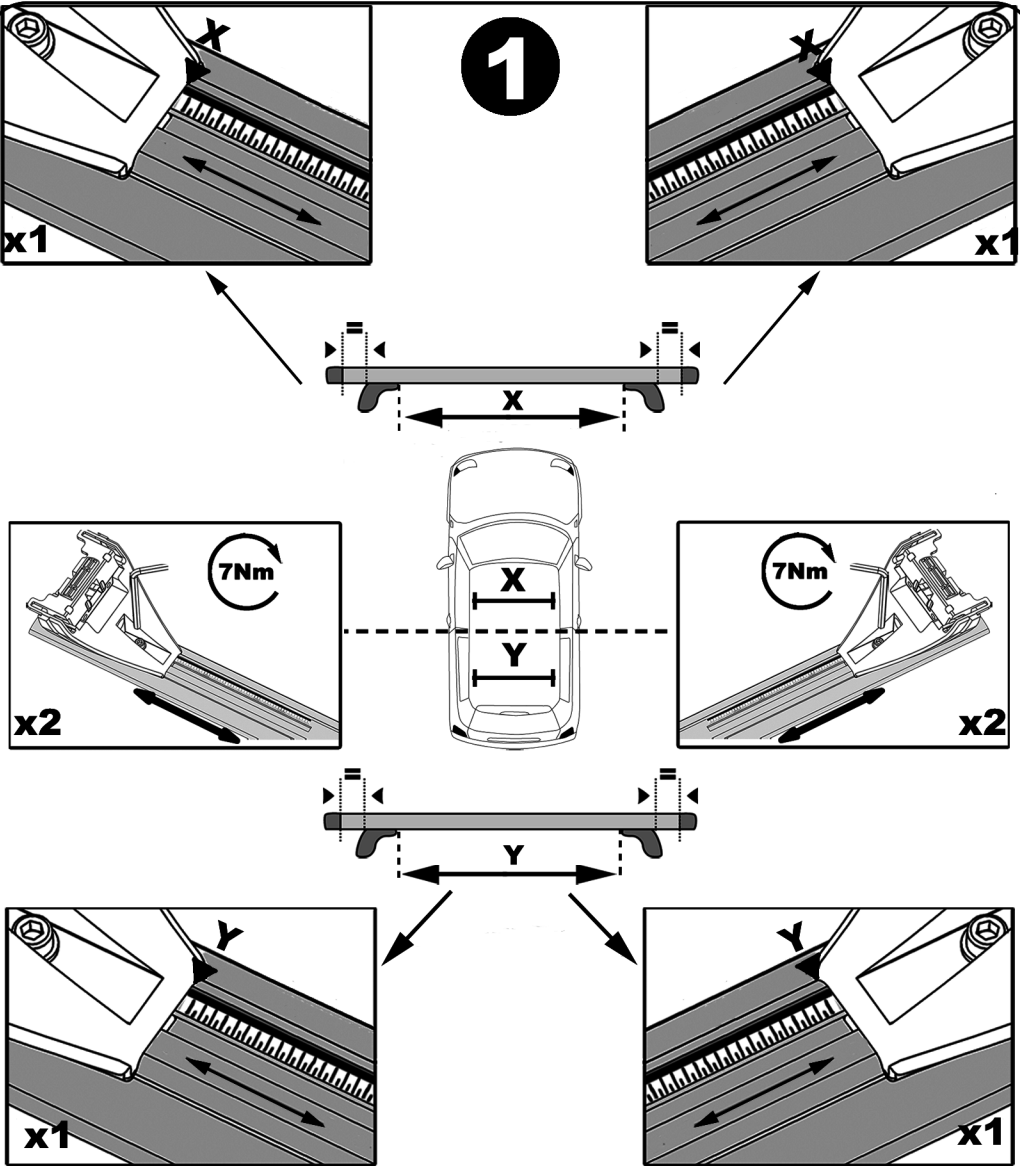

	X	Y
Peugeot 208 5p	86 cm	83 cm

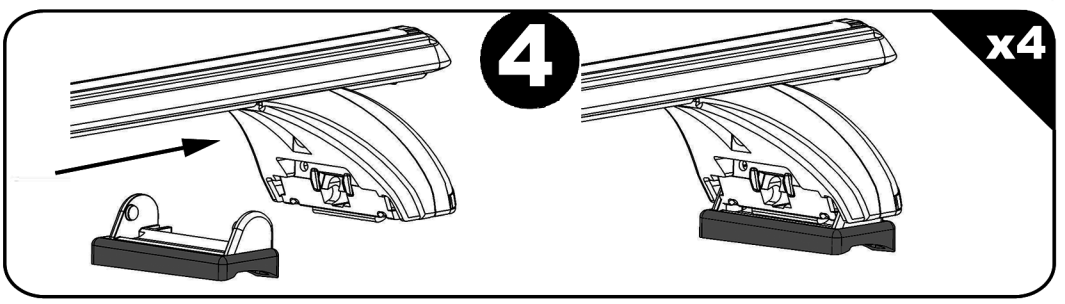
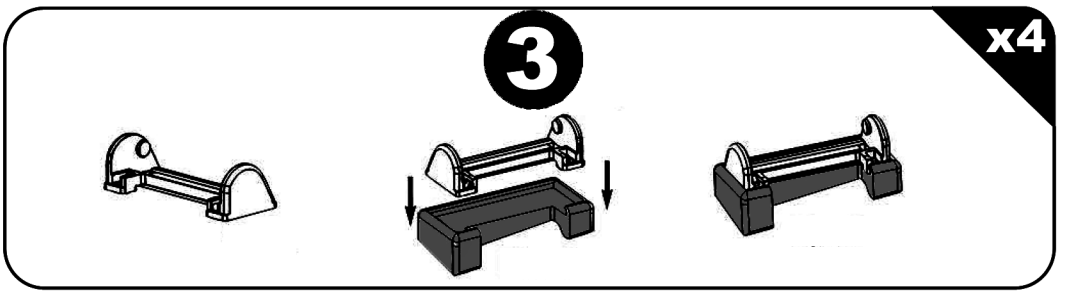
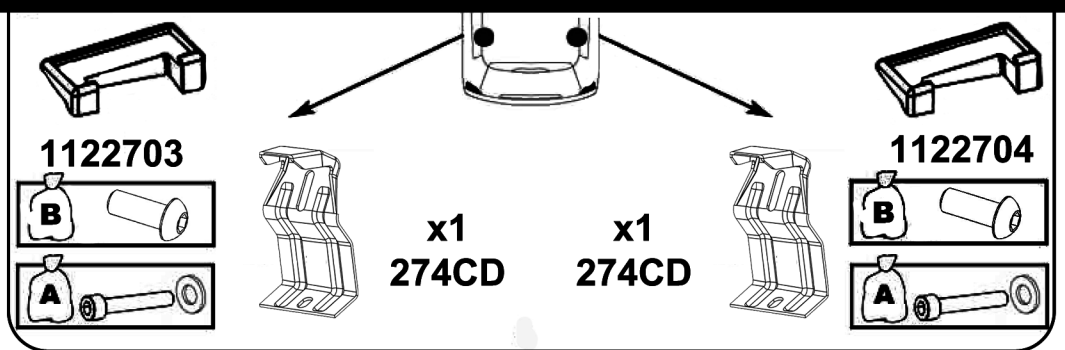
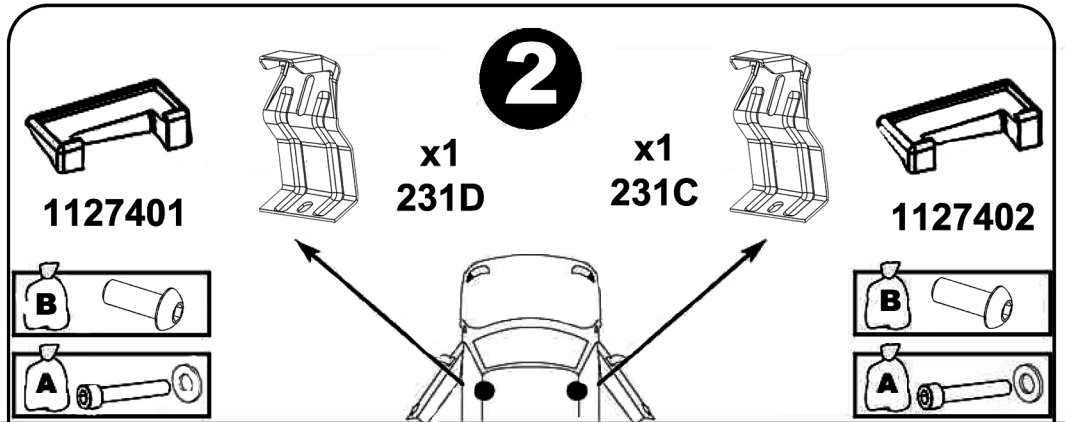

5

x4

A)

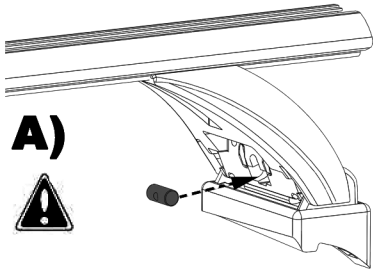

B)

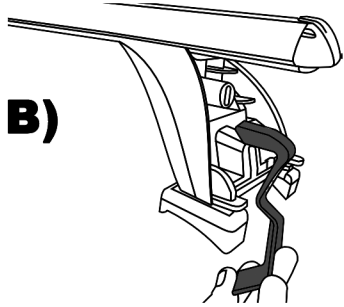

C)

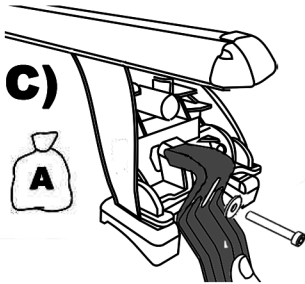

D)

x2

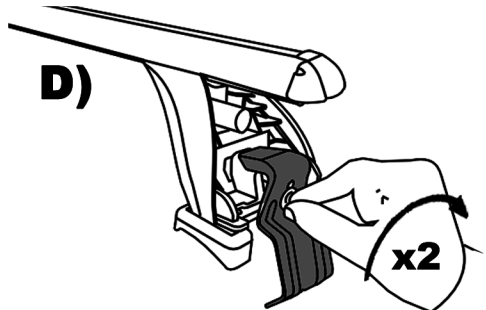

6

x2

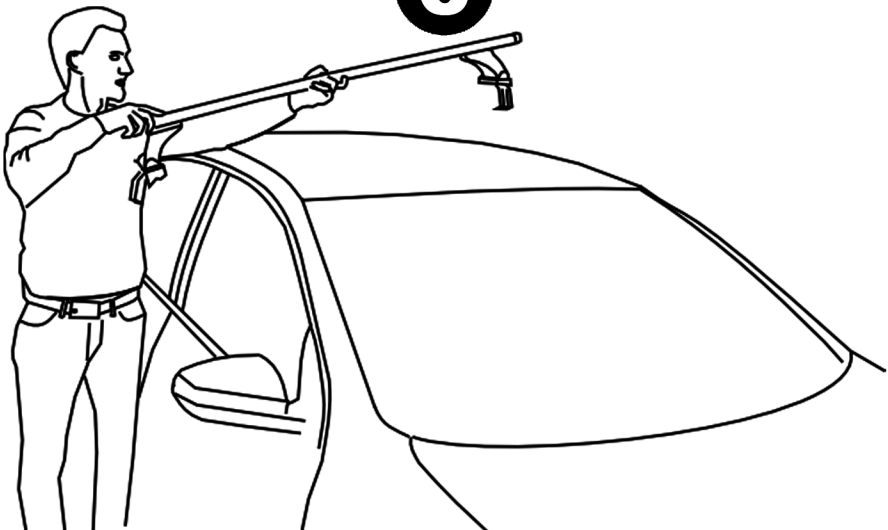

7

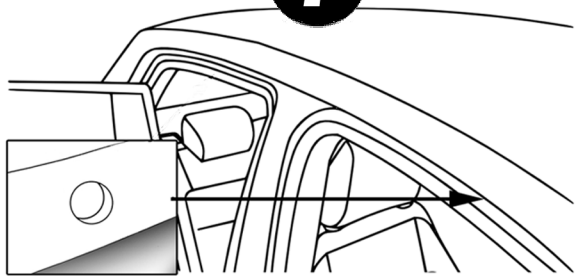

x2

A)

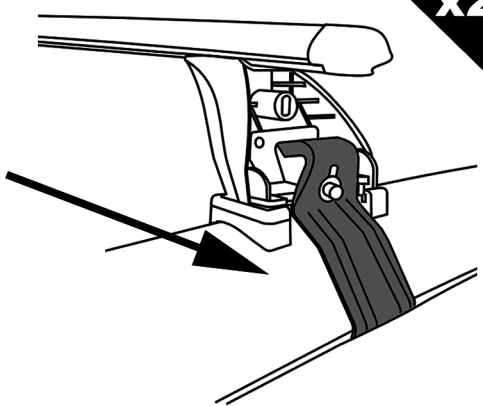
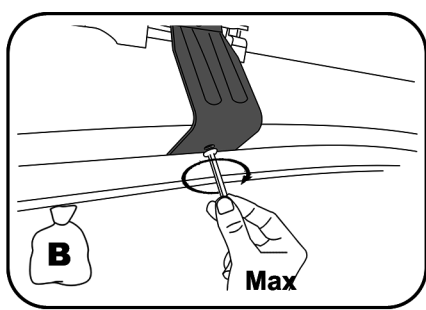

B)

6Nm

Push

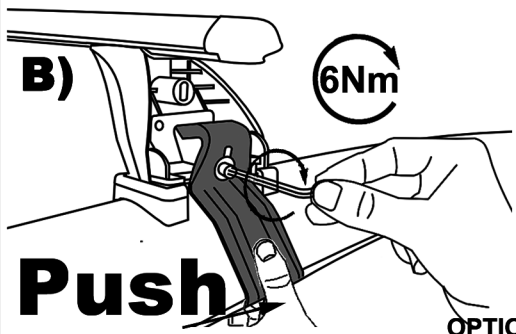

C)

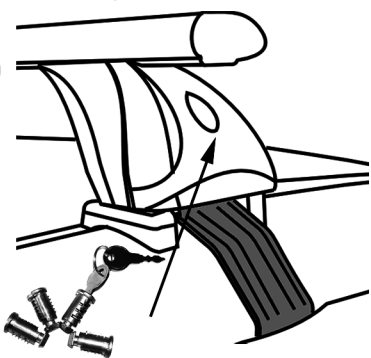

OPTION 156.002

F Serrer alternativement chaque côté
E Alternare il serraggio delle viti
I Serrare alternativamente
P Aperte alternadamente
GB Tighten alternately
D Die Schrauben abwechselnd anziehen

NL Afwisselend aan de linker en de rechterkant aandraaien
S Dra åt växelvis
FIN Kierrä vuorotellen
EST Pinguldage vaheldumisi
LAT Pievelciēt pamāšus
LIT Uzsukinėkite pakaitomis
PL Sruby dokrecaj naprzemiennie

CZ Pokretla bagaznika dokrecaj dokrecaj naprzemiennie
SK Dotahujte striedavo
SLO Privijajte izmenicno
HR Naizmjenično zategnite
HU Egymástól függetlenül szorítandó
TR Dönüsümlü sikin

8

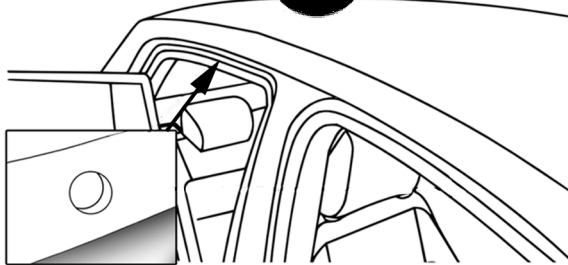

A)

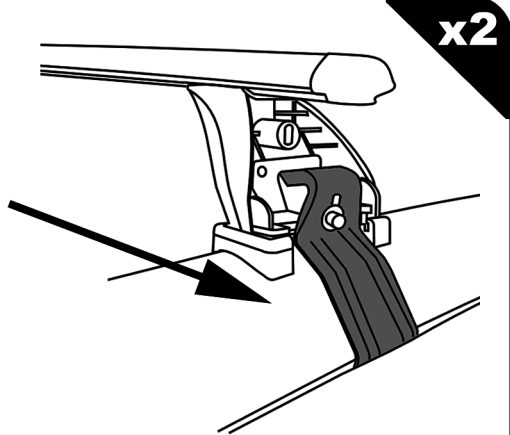
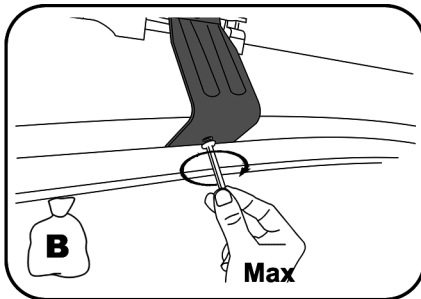

B)

6Nm

Push

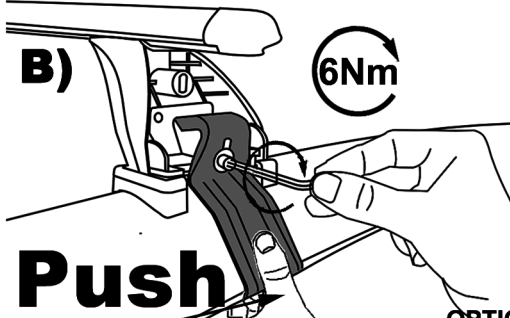

C)

OPTION 156.002

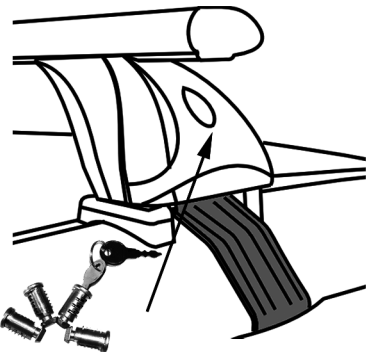

F Serrer alternativement chaque côté
E Alternare il serraggio delle viti
I Serrare alternativamente
P Aperte alternadamente
GB Tighten alternately
D Die Schrauben abwechselnd anziehen

NL Afwisselend aan de linker en de rechterkant aandraaien
S Dra át växelvis
FIN Kierrä vuorotellen
EST Pinguldage vaheldumisi
LAT Pievelciēt pamāšus
LIT Uzsukinėkite pakaitomis
PL Sruby dokreczej naprzemiennie

CZ Pokretla bagaznika dokrecaj dokrecaj naprzemiennie
SK Dotahujte striedavo
SLO Privijajte izmenicno
HR Naizmjenično zategnite
HU Egymástól függetlenül szorítandó
TR Dönüsümlü sikin

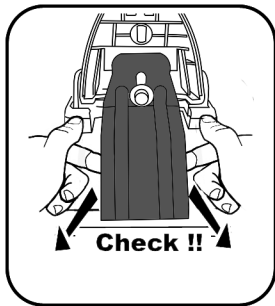

9

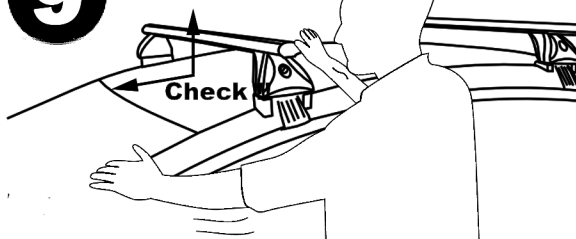

10

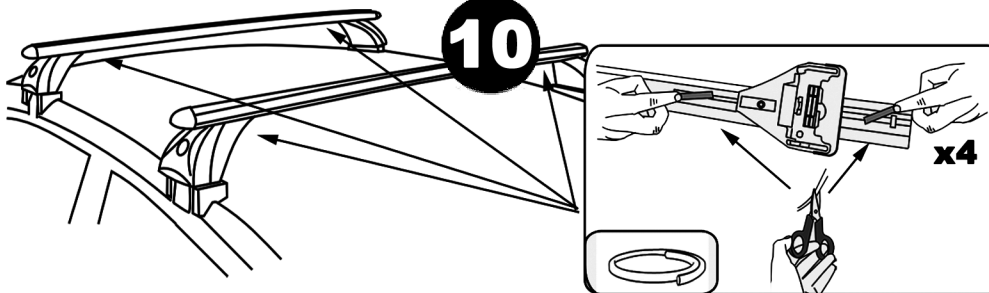

Démontage - Desmontaje - Smontaggio - Desmontagem - Disassembly - Demontage

