

TYPE A

Ref.: 156296



ISO/PAS 11154



CITY CRASH TEST



n° 296



Kia Cee'd (skydome)

5

01/2012->

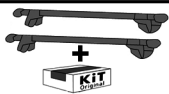

5 kg + xx Kg = 75 kg max

Ne pas dépasser la charge maximale des barres. Ne pas dépasser la charge maximale indiquée par le constructeur du véhicule

Non superare il carico massimo delle barre portatutto. Non superare il carico massimo indicato dal costruttore del veicolo

Carga máxima admisible indicada en la caja de las barras de techo. No exceda la carga máxima permitida por el fabricante del vehículo.

Maximum allowable load indicated on the box of roof bars. Do not exceed the maximum load allowed by the vehicle manufacturer.

Maximal zulässige belastung angegeben auf der box der dachreling. Überschreiten sie nicht die maximale belastung durch den fahrzeughersteller zugelassen.

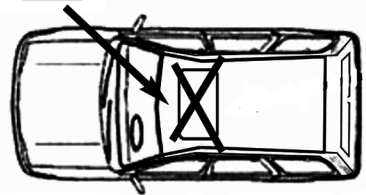
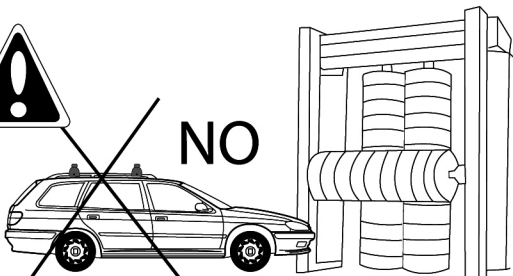
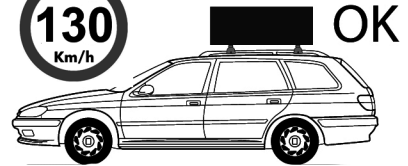
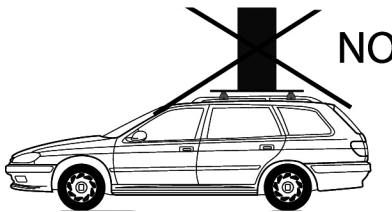
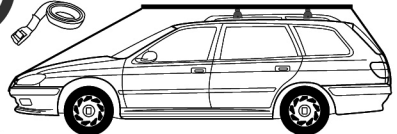
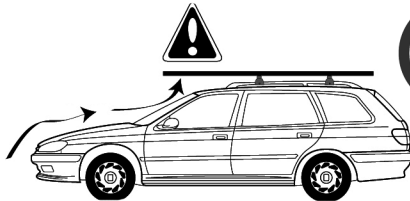

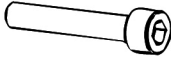
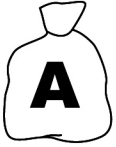

**M6x50
x4**

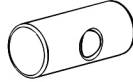

**162100001
x4**



**6591.06
x4**

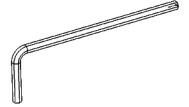

**100005
x1**

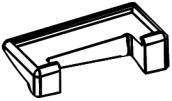

**x1
1127603**

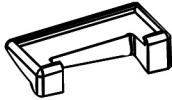

**x1
1127603**

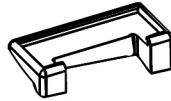

**x1
1127604**

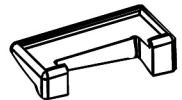

**x1
1127604**

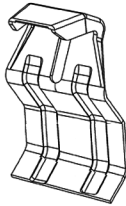

**x2
237C**

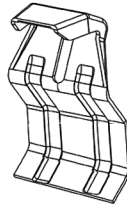

**x2
237D**

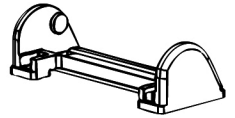

**x4
214800001**



	X	Y
Kia Cee'd II (skydome)	96,5 cm	95 cm

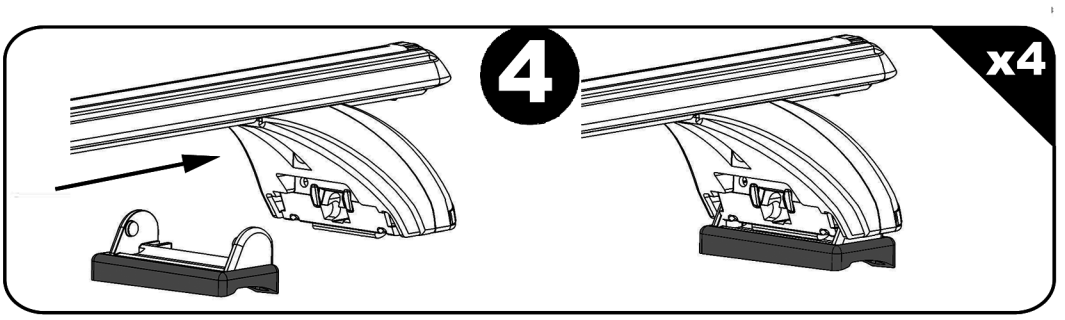
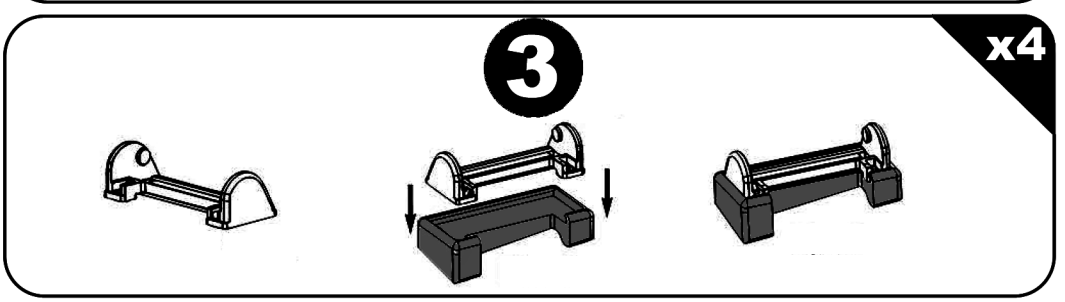
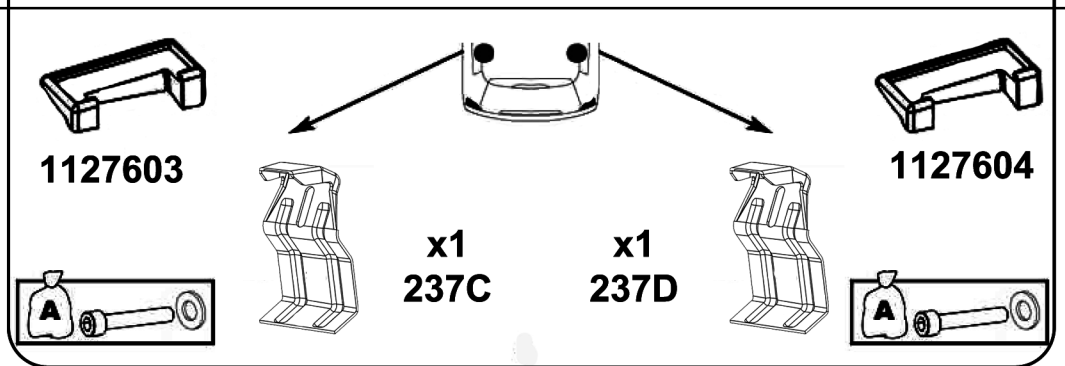
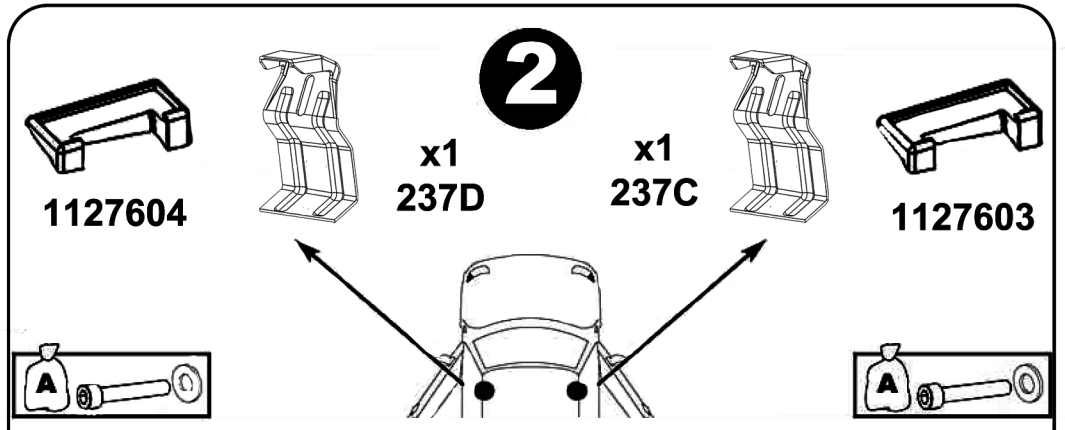

5

x4

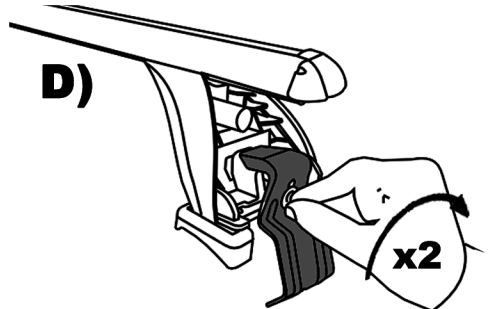
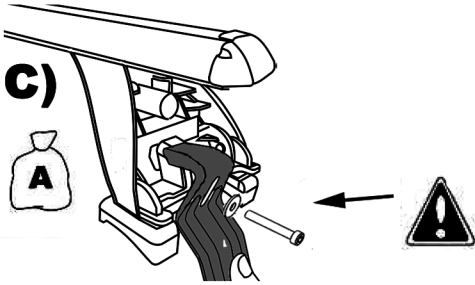
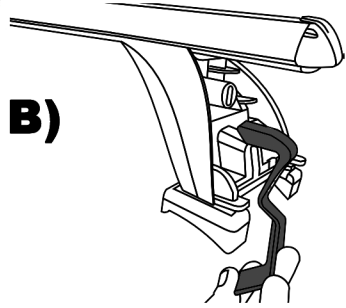
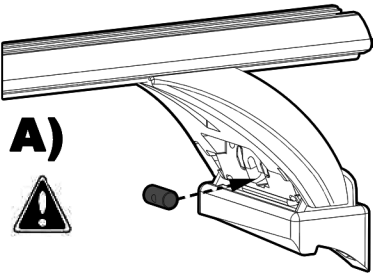

6

x2

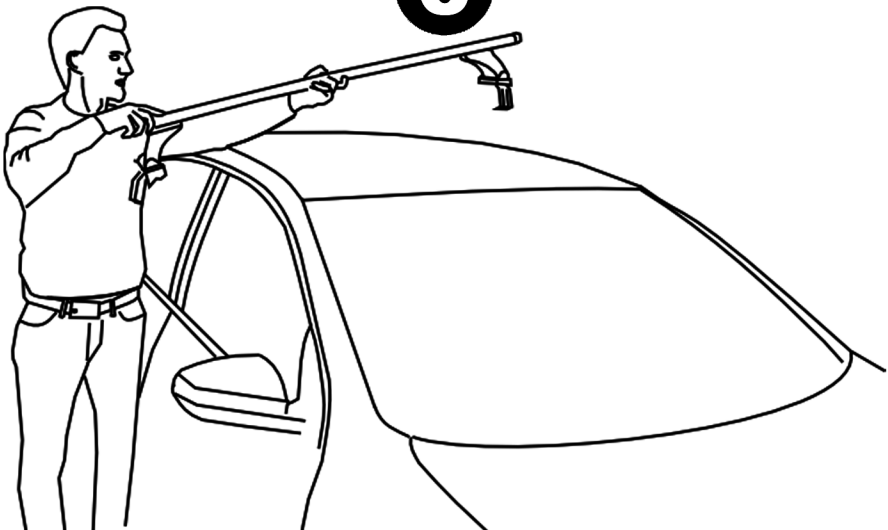

7

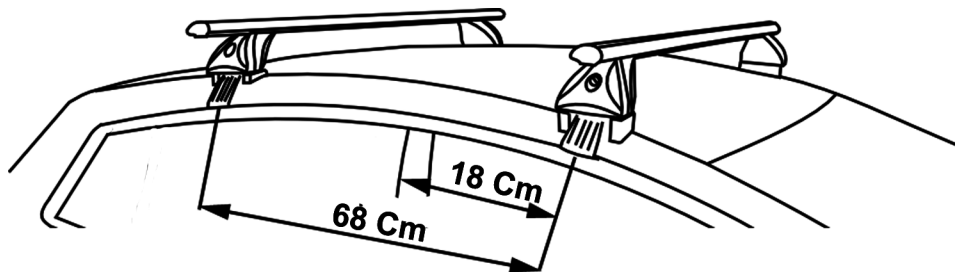

x4

A)

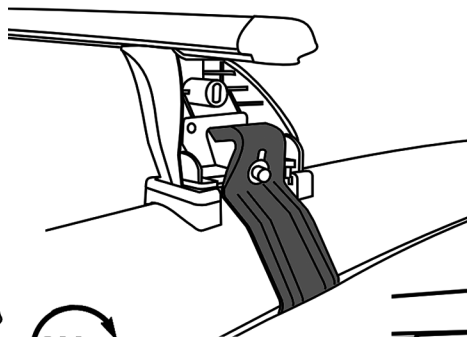

6Nm

B)

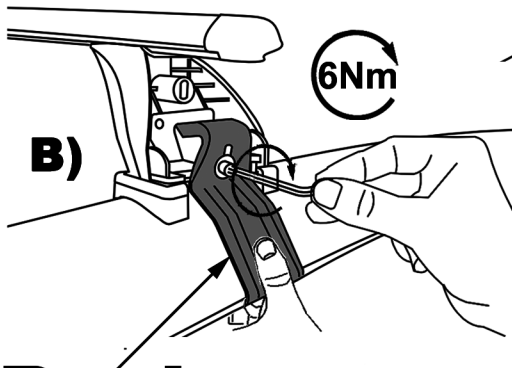

C)

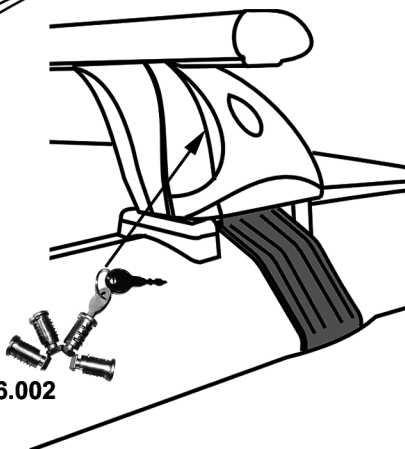

Push

OPTION 156.002

- F** Serrer alternativement chaque côté
E Alternare il serraggio delle viti
I Serrare alternativamente
P Aperte alternadamente
GB Tighten alternately
D Die Schrauben abwechselnd anziehen

- NL** Afwisselend aan de linker en de rechterkant aandraaien
S Dra åt växelvis
FIN Kierrä vuorotellen
EST Pinguldage vaheldumisi
LAT Pīvelciēt pamāšus
LIT Uzsukinkite pakaitomis
PL Sruby dokrecaj naprzemiennie

- CZ** Pokretla bagaznika dokrecaj dokrecaj naprzemiennie
SK Dotahujte striedavo
SLO Privijajte izmenicno
HR Naizmjenicno zategnite
HU Egymástól függetlenül szorítandó
TR Dönüşümlü sıkın

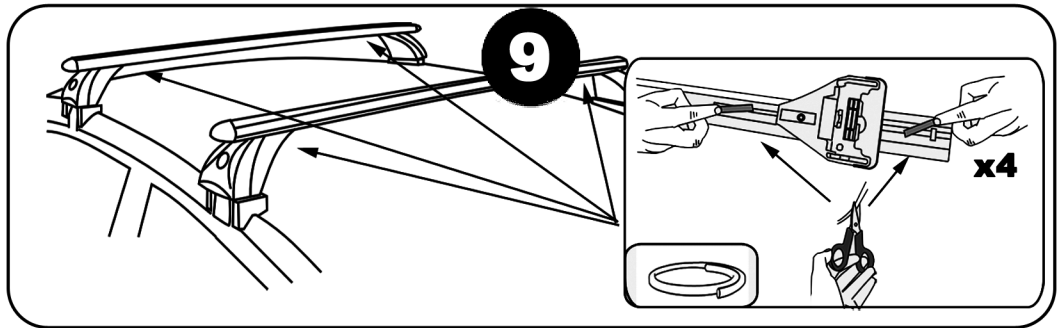
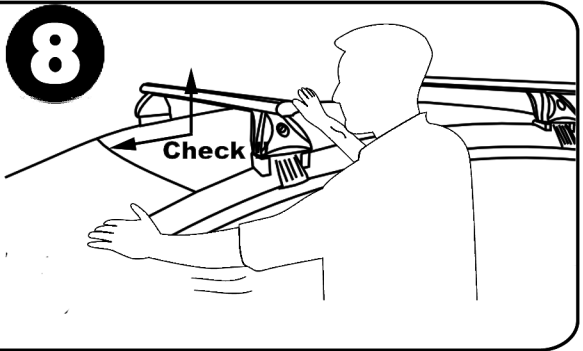
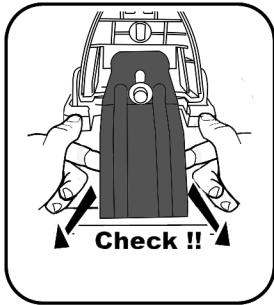

Démontage - Desmontaje - Smontaggio - Desmontagem - Disassembly - Demontage

