



## FIRST TIME INSTALLATION

- \* REMOVE PARTS FROM INSIDE THE PACKAGE AND CHECK THEM ALL
- \* CONTACT YOUR DEALER IF ANY PART IS MISSING OR DAMAGED
- \* USE THE EQUIPMENT SPECIFIED FOR INSTALLATION

### ASSEMBLY INSTRUCTIONS (ROOF RACK)

Product Code: MC02003

### COMPATIBLE VEHICLES

HND CRV (MK5) SUV 12-18/19+  
CADL XT5 SUV 16+

### PACKAGE INCLUDED

1-	TURTLE AIR 2 CHASSIS	4
2-	NO.5 ALLEN WRENCH	1
3-	CLOTH KEYCHAIN	1
4-	C9	4
5-	2003 PLASTIC PART	4
6-	M6x35 INBUS BOLT	4
7-	M6 1/2 WASHER	4
8-	M6x20 INBUS BOLT	8
9-	M6 WASHER	8
10-	M6 SPEEDNUT	4

ZIPLOCK BAG

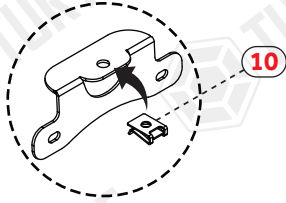

Klipsi metal demirin üst kısmına yerleştiriniz.  
Place the clips top of the metal bracket.

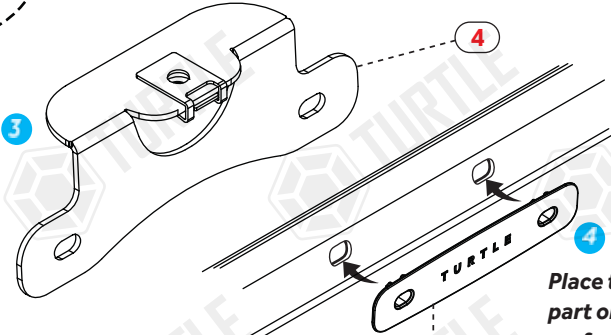

Plastik parçayı çitanın iç yüzeyine yerleştiriniz.  
Place the plastic part on the inner surface of the rail.

Place the plastic part on the inner surface of the rail.

MAX 5NM

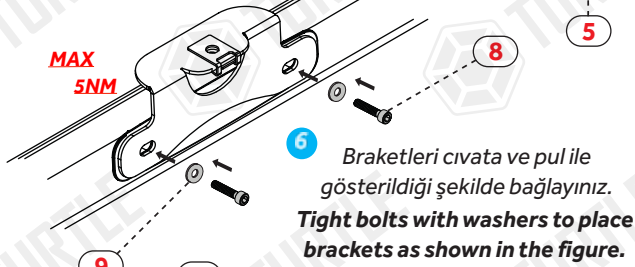

Metal braketlerin yönü şekilde gösterildiği gibidir.  
Metal brackets have to place as shown in the figure.

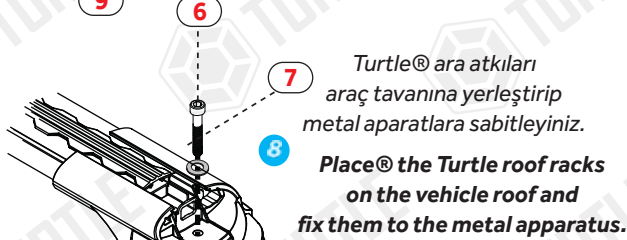

MAX 5NM

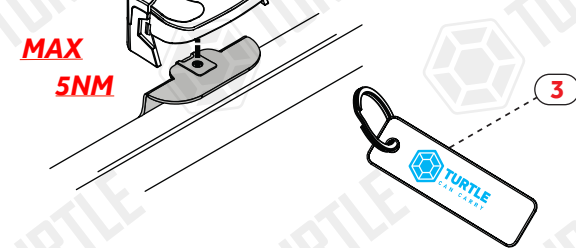

Profilleri ortaldıktan sonra yatay sabitleme cıvatalarını sıkınız.  
After centering the profiles, tighten the horizontal fixing bolts.

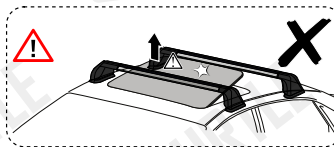

80 Km/h  
50 Mph

130 Km/h  
80 Mph

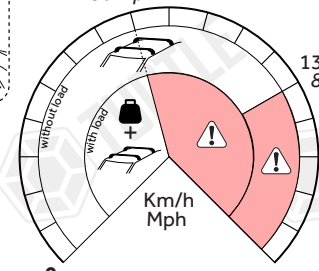

Max. Load  
75 kg

- \* Kullanım amacı; Aracın bagajı yeterli olmadığı durumlarda araç tavanında yük ve eşya taşımak.
- \* Purpose of usage; Carrying cargo and goods on the vehicle's roof when the vehicle's trunk is not sufficient.