

EN Fitting Instructions for Basic Carrier  
PL Instrukcja systemu montażu

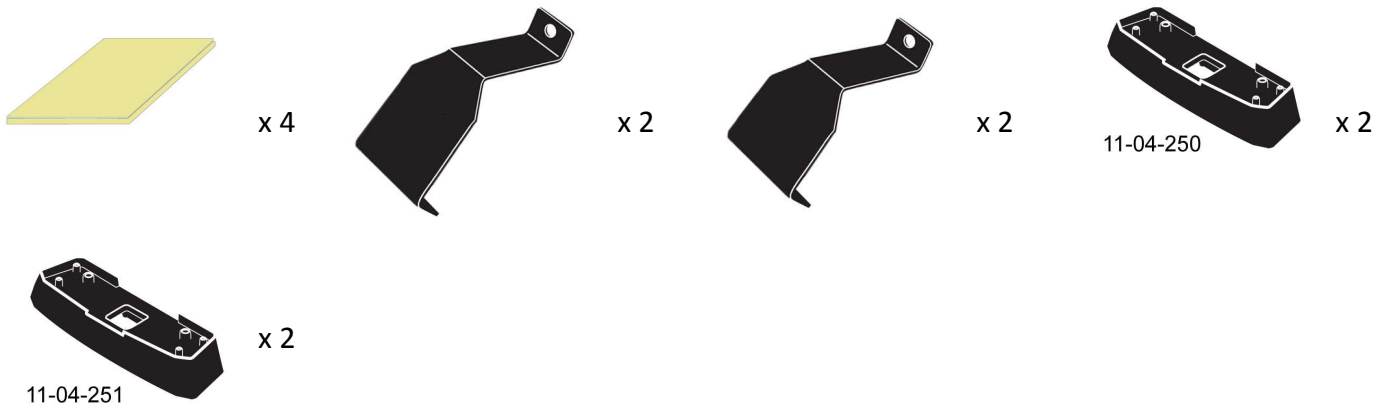

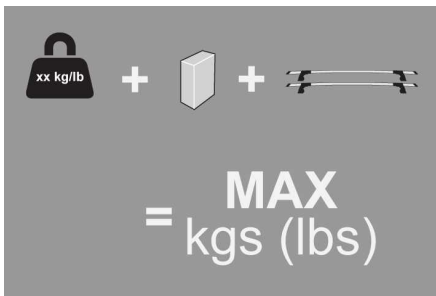

## MAX kgs (lbs)

🚩 W/P WHD

### Dodge

- Avenger , 4dr Sedan 08-+
- Avenger , 4dr Sedan 08-10
- Avenger , 4dr Sedan 08-10
- Avenger , 4dr Sedan 08-10
- Avenger , 4dr Sedan 08-14

🚩	W/P	WHD
CN	75 kgs (165 lbs)	75 kgs (165 lbs)
NZ	75 kgs (165 lbs)	75 kgs (165 lbs)
EU	75 kgs (165 lbs)	75 kgs (165 lbs)
AU	75 kgs (165 lbs)	75 kgs (165 lbs)
US	75 kgs (165 lbs)	75 kgs (165 lbs)

## First Time Installation



- Remove parts from inside the package and check. Contact your dealer if any parts are missing or damaged.



- This kit fits type A, B, C and D.
- These instructions show type A crossbar fitted. They also apply to type B, C and D.

**NOTE: Clamp images in these instructions may not be representative of the clamps in this kit**

- Use keys to remove covers.



- Use hex screwdriver to reverse adjusting screw 10 turns.



- Press adjusting screw and pull crossbar legs out. Refer to the crossbar instructions for crossbar adjustment method.
- Ensure each end of the crossbar is adjusted equally.





- Remove locking screw.

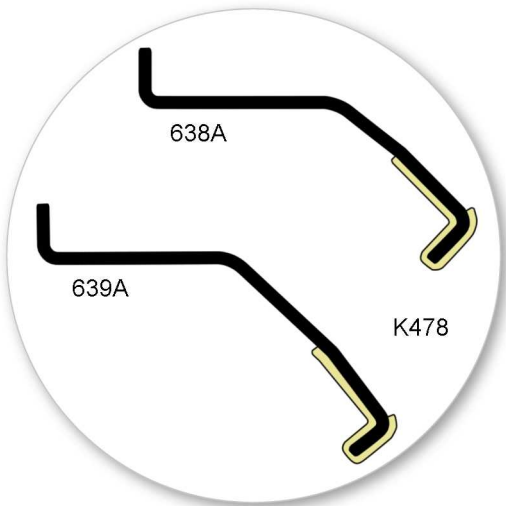

- Apply protective strip as shown.  
Trim if required.

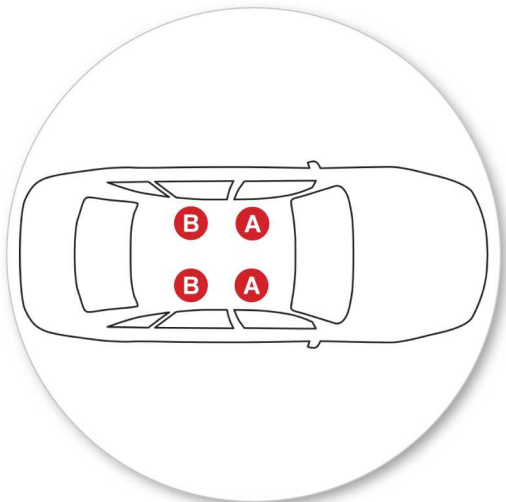

- Letters refer to the part numbers stamped on clamps.
- Clamp Part Number:  
A = 638A  
B = 639A



- Attach clamp to each leg. NOTE; clamps may have labels showing their positions on the vehicle (For example; "Front Right").



- Refit locking screw so that it goes through the hole in the clamp. Do not begin to tighten the locking screw.



- Refer to the underside of the pad for the part number.

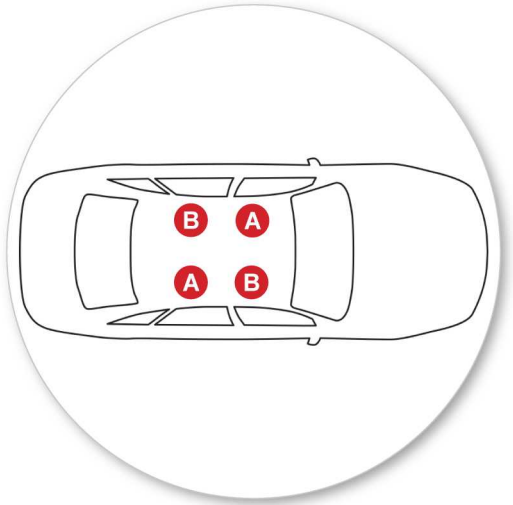

- Letters refer to the pad part numbers and position.
- Pad Part Number:  
A = 11-04-250  
B = 11-04-251



- Fit rubber pads (supplied with fitting kit) to foot. Pad may vary in shape to that shown.



- Make sure the pad fits into the holes underneath the foot.
- Repeat for all legs.

## Fitment



- Place crossbar on vehicle. Minimum recommended spacing between the bars is 700mm (27 1/2") (unless otherwise stated).
- Clamps directly to edge of roof under the doors
- Please check the rear of this manual for information relating specifically to your vehicle.



- Adjust the legs on the crossbar so that they are positioned equally from the ends of the crossbar, and the clamps engage firmly on the body work of the vehicle.



- Tighten adjusting screw to 5 Nm (3.7 ft lb) hand tight.



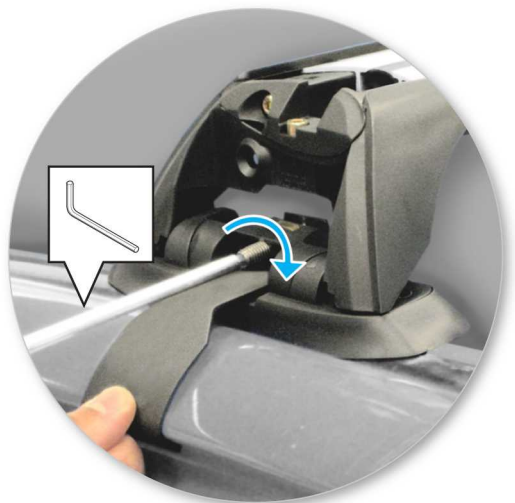

- Tighten locking screw on both legs evenly.



- Check crossbar is securely attached to the vehicle.



- Use keys to fit and lock covers

**CAUTION: Recheck all fasteners immediately after a load is applied to the crossbars.  
Regularly check screws are tight.**

---

## Maintenance

- Clean the car roof and surfaces of the product that will be in contact with the car roof.
- Follow the fitting instructions for fitting the product to your vehicle. Make sure all steps are carried out in order.
- Set crossbars a minimum distance of 700mm (27 1/2") apart where no other distance is specified in the fitting instructions. This is especially important when carrying long loads.
- Check unit is securely attached whenever you refit it to the vehicle. If the unit feels loose, refer to the fitting instructions and readjust.
- Some glass/panoramic roofs and radio antennae may not be able to be used when the product is fitted.
- Do not modify this product.
- Refer to the maximum permitted load capacity specified in the fitting instructions. Do not exceed the vehicle manufacturers roof load rating if it is lower than the maximum load capacity specified in the fitting instructions.
- Loads should not overhang the sides of the product and be evenly distributed with the lowest possible centre of gravity.
- Long loads should be secured with non-elastic straps to the front and rear of the vehicle.
- Objects with pointed ends (e.g. ski poles) should be carried with the pointed ends to the rear of the vehicle.
- Remove all loose or removable objects from the load prior to loading.
- Make sure all loads are securely fastened with non-elastic straps. Check regularly during longer journeys.
- A loaded roof rack system can alter the performance of your vehicle. Be especially aware of the effects of side winds, changing of direction, and braking performance. Avoid rapid acceleration and deceleration. Drive carefully.
- Note that the total height of the vehicle increases when upright loads are carried.
- Products should be locked during transport if they have locks fitted.

- Check and replace worn out or defective parts.
  - Keep the product clean and maintained.
  - Never drive into a car wash with the roof rack system fitted.
  - Lubricate locks and adjusting screws at regular intervals.
  - Remove the products from the vehicle when not in use. Make sure all loose parts are stored safely.
- 

- Yakima Products, Inc.  
15025 SW Koll Pkwy.  
Beaverton, OR 97006-6056  
USA

[www.whispbar.com](http://www.whispbar.com)  
[www.whispbar.ca](http://www.whispbar.ca)

---

## Pierwszy montaż

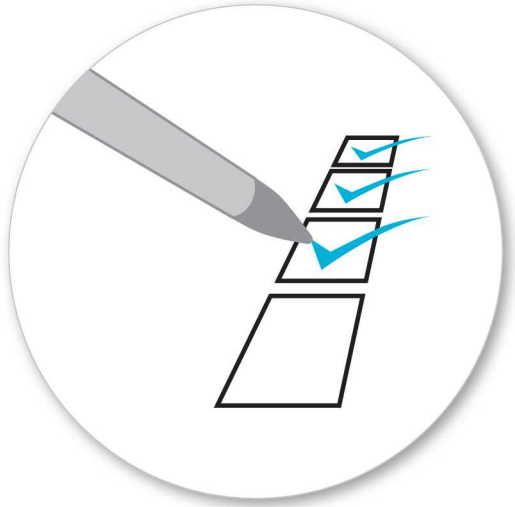

- Sprawdź zawartość opakowania i upewnij się, czy zawiera wszystkie części znajdujące się na liście. Jeśli nie, skontaktuj się z odpowiednim sklepem.



- Kit pasuje do belek typu A, B, C oraz D.
- Instrukcja opisuje sposób montażu belek typu A. Może być również stosowana do belek typu B, C i D.

**UWAGA: Zdjęcia łap mogą różnić się w zależności od rodzaju kitu**

- Odkręć osłony za pomocą klucza.



- Zdejmij osłony za pomocą klucza.



- Przyciśnij i usuń blokadę. Zamontuj stopy.
- Sprawdź czy oba końce belek mają taką samą długość.





- Odręć śrubę zabezpieczającą.

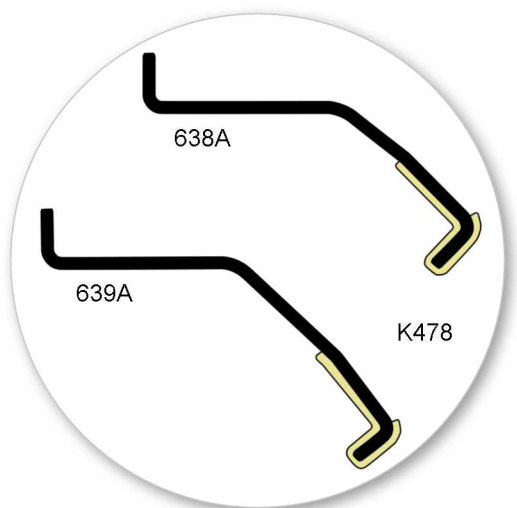

- Nałożyć pasek ochronny, jak pokazano. Zabezpiecz tsmą.

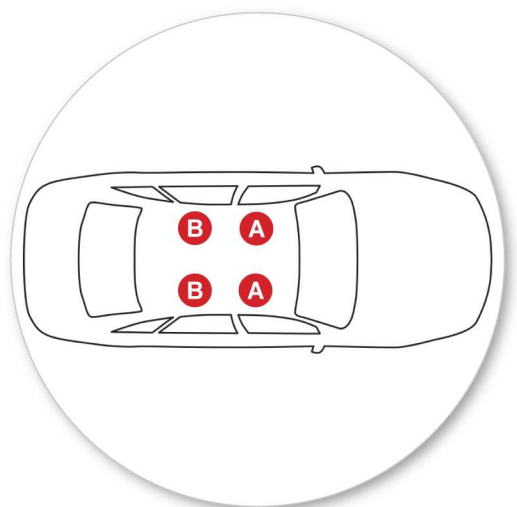

- Litery odnoszą się do oznakowań na łapkach
- Numer łapy:  
A = 638A  
B = 639A



- Doczep łąpki do kitu. Uwaga: Na łąpkach umieszczona jest informacja odnośnie ich rozmieszczenia. ( Np. Prawy przód)



- Umieść śrubę w otworze łąpki. Nie dokręcaj śruby zbyt mocno.



- Zobacz numer pod spodem łąpki.



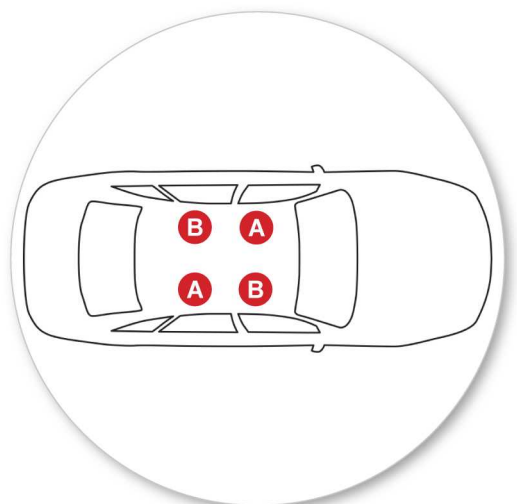

- Litery oznaczają podkładki oraz sposób ich rozmieszczenia.
- Rozmieszczenie podkładek:  
A = 11-04-250  
B = 11-04-251



- Nałóż gumowe podkładki na stopę. Podkładki mogą różnić się kształtem.



- Upewnij się, czy dobrałeś odpowiednią podkładkę.
- Powtórz czynność dla reszty stóp.

## Montaż



- Umieść belki na dachu. Zalecana odległość między belkami wynosi 700mm.
- Zamocuj łapy na samym brzegu dachu tuż pod drzwiami
- Na końcu instrukcji znajdziesz specyfikacje dla twojego samochodu.



- Zamontuj stopy w tych samych miejscach na obu końcach belki. Zamontuj łapki.



- Dokręć z siłą 5 Nm / 3.7 ft lb.



- Dokręć śruby na każdej stopie.



- Upewnij się, czy belka została poprawnie zamontowana



- Zamknij osłony za pomocą klucza.

**UWAGA: Sprawdź czy dokładnie dokręciłeś śruby**

---

## Zasady użytkowania

- Przed zamontowaniem belek oczyść powierzchnię dachu samochodu.
- Postępuj zgodnie z instrukcją montażu danego zestawu. Sprawdź czy nie pominąłeś żadnego punktu.
- Jeżeli nie pisze inaczej, ustaw belki w odległości min. 700mm. Jest to szczególnie istotne przy przewożeniu długich przedmiotów.
- Po każdym montażu upewnij się, że belki ściśle przylegają do dachu. Jeżeli zauważysz luz, zamontuj bagażnik jeszcze raz postępując zgodnie z instrukcją.
- Po założeniu produktu może nie być możliwy montaż pewnych typów szklanych dachów panoramicznych i anten radiowych.
- Nie modyfikuj zestawu montażowego.
- Stosuj się do maksymalnej ładowności ładunku zamieszczonej w instrukcji. Nie przekraczaj ładowności określonej w instrukcji samochodowej.
- Przewożony ładunek nie powinien wystawać poza brzożo bagażnika.
- Długie przedmioty powinny być zabezpieczone z przodu i z tyłu taśmą.
- Przedmioty z ostrymi końcami (narty) powinny być przewożone tyłem do przodu.
- Usuń wszystkie luźne przedmioty przed załadunkiem.
- Upewnij się, że przewożony ładunek został zabezpieczony taśmami.
- Jazda samochodem z bagażnikiem na dachu zmienia zachowanie samochodu. Zachowaj szczególną ostrożność podczas zmiany kierunku, hamowania, przyspieszania czy zwalnia.
- Pamiętaj, że po zamontowaniu bagażnika dachowego samochód zwiększa swoją wysokość.
- Wszystkie zamki w przewożonych przedmiotach powinny być zamknięte.
- Wymień wszystkie wyeksploatowane i uszkodzone części.
- Utrzymuj bagażnik w czystości.
- Nie korzystaj z myjni jeśli masz zamontowany bagażnik na dachu.

- Regularnie naoliwiaj zamki i zawiasy.
  - Zdemotuj bagażnik dachowy jeśli go nie używasz.
- 

- Yakima Products, Inc.  
15025 SW Koll Pkwy.  
Beaverton, OR 97006-6056  
USA

[www.whispbar.pl](http://www.whispbar.pl)

---

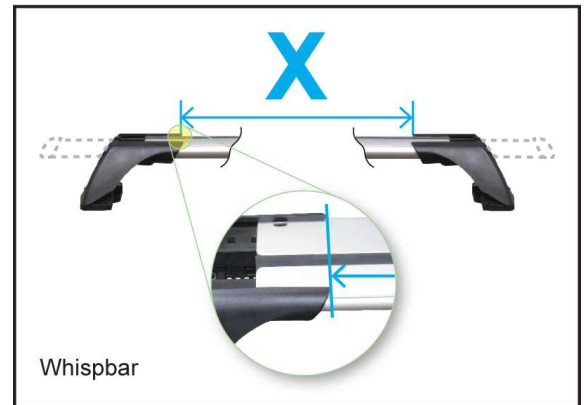
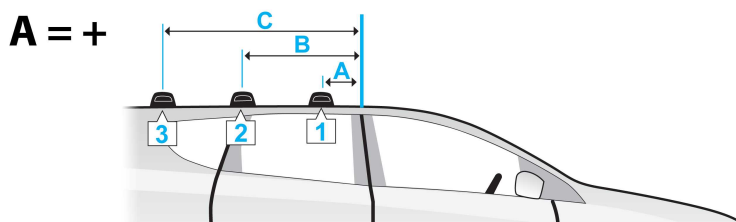
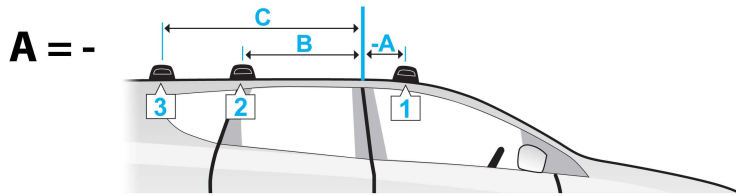

	A	B	C	X		
				1	2	3
Avenger, 4dr Sedan 08-+ (CN)	-300mm -11 -13/16ths"	400mm 15 3/4ths"	-	937mm 36 7/8ths"	918mm 36 1/8ths"	-
Avenger, 4dr Sedan 08-10 (NZ)	-300mm -11 -13/16ths"	400mm 15 3/4ths"	-	937mm 36 7/8ths"	918mm 36 1/8ths"	-
Avenger, 4dr Sedan 08-10 (EU)	-300mm -11 -13/16ths"	400mm 15 3/4ths"	-	937mm 36 7/8ths"	918mm 36 1/8ths"	-
Avenger, 4dr Sedan 08-10 (AU)	-300mm -11 -13/16ths"	400mm 15 3/4ths"	-	937mm 36 7/8ths"	918mm 36 1/8ths"	-
Avenger, 4dr Sedan 08-14 (US)	-300mm -11 -13/16ths"	400mm 15 3/4ths"	-	937mm 36 7/8ths"	918mm 36 1/8ths"	-

## LIMITED LIFETIME WARRANTY

Technical Assistance or Replacement Parts: Contact your dealer or visit: [www.whispbar.com](http://www.whispbar.com) or call (888) 925-4621 Monday through Friday, 7:00am to 5:00pm, PST

This limited lifetime warranty covers all Whispbar-brand products\* and rack components manufactured by Yakima Products, Inc. (Yakima), and is effective for as long as the original retail purchaser owns the product. This warranty terminates when the original retail purchaser sells or otherwise transfers the product to any other person. Subject to Yakima's inspection of the product, Yakima will remedy defects in materials and/or workmanship by repairing or replacing, at Yakima's option, the defective product without charge for parts or labor, subject to the limitations and exclusions described in this warranty. Yakima may elect, at its option, not to repair or replace a defective product, in which case Yakima will issue to the original retail purchaser, at Yakima's option, either a refund equal to the purchase price paid for the product, or a credit to be used toward the purchase of new Whispbar products or rack components. This warranty does not cover problems caused by normal wear and tear (including, but not limited to, scratches, dents, or aesthetic oxidation of surfaces), accidents, unlawful vehicle operation, or modifications or repairs not performed or authorized by Yakima. In addition, this warranty does not cover problems resulting from conditions beyond Yakima's control including, but not limited to, theft, misuse, overloading, or failure to assemble, mount or use the product in accordance with Yakima's written instructions or guidelines included with the product or made available to the original retail purchaser. If a product is believed to be defective, the original retail purchaser should contact the Whispbar dealer from whom it purchased the product, who will give the original retail purchaser instructions on how to proceed. If the original retail purchaser is unable to contact the Whispbar dealer, or the dealer is not able to remedy the defect, the original retail purchaser should contact Yakima by e-mail at: [yakwarranty@yakima.com](mailto:yakwarranty@yakima.com), or phone 888.925.4621 for shipping instructions. Upon contacting Yakima directly, a Yakima technician will provide the original retail purchaser with appropriate instructions for returning the product to Yakima. The original retail purchaser will be responsible for the cost of mailing the product to Yakima. In order to receive any remedy under this warranty (either from a Whispbar dealer, or from Yakima directly), proof of purchase in the form of an original purchase invoice or receipt is strictly required.

### LIMITATION OF LIABILITY

REPAIR OR REPLACEMENT OF A DEFECTIVE PRODUCT, OR THE ISSUANCE OF A REFUND OR CREDIT (AS DETERMINED BY YAKIMA), IS THE ORIGINAL RETAIL PURCHASER'S EXCLUSIVE REMEDY UNDER THIS WARRANTY. DAMAGE OR INJURY TO THE ORIGINAL RETAIL PURCHASER, TO HIS OR HER VEHICLE, CARGO, OR PROPERTY, AND/OR TO ANY OTHER PERSON OR PROPERTY IS NOT COVERED BY THIS WARRANTY. THIS WARRANTY IS EXPRESSLY MADE IN LIEU OF ANY AND ALL OTHER EXPRESS WARRANTIES, WHETHER ORAL OR WRITTEN.

YAKIMA'S SOLE LIABILITY IS LIMITED TO THE REMEDY SET FORTH ABOVE. IN NO EVENT WILL YAKIMA BE LIABLE FOR ANY DIRECT, INDIRECT, CONSEQUENTIAL, INCIDENTAL, SPECIAL, EXEMPLARY, OR PUNITIVE DAMAGES OR FOR ANY OTHER DAMAGES OF ANY KIND OR NATURE (INCLUDING, BUT NOT LIMITED TO, LOST PROFITS OR LOST SALES).

SOME STATES DO NOT ALLOW THE EXCLUSION OR LIMITATION OF INCIDENTAL OR CONSEQUENTIAL DAMAGES, SO THE ABOVE LIMITATIONS MAY NOT APPLY TO YOU.

THIS WARRANTY GIVES YOU SPECIFIC LEGAL RIGHTS, AND YOU MAY ALSO HAVE OTHER RIGHTS WHICH VARY FROM STATE TO STATE.



**WARRANTY & DISCLAIMER**

**Yakima Australia Pty Ltd ABN 58 154 440 221**  
**17 Hinkler Court, Brendale QLD 4500**  
**Tel: 0800 4776 722 (NZ) or 1800 143 548 (AU)**  
**Email: warranty@yakima.co.nz or warranty@yakima.com.au**

1. Where the product is supplied to the customer for other than business purposes within the meaning of section 43 of the New Zealand Consumer Guarantees Act 1993, the provisions of that Act shall apply. It is important that anyone who fits or uses this product does so in accordance with the manufacturer's instructions.
2. Where the product is supplied to the customer for business purposes within the meaning of section 43 of the New Zealand Consumer Guarantees Act 1993, the provisions of that Act and all other representations or terms (including any conditions or warranty expressed or implied by law, statute or otherwise) not expressly included in this leaflet are hereby expressly excluded shall have no effect and the clauses (a) and (b) shall apply.
3. Subject to the **Additional Information (Australia)**, where the product is supplied and purchased in Australia, the following shall apply:
  - a. THE SUPPLIER WARRANTS the product to be free from defects in materials and/or workmanship for a limited lifetime from the date of original purchase (the warranty period). Proof of purchase is required. Subject to the limitations and exclusions set out below, the Supplier hereby agrees to remedy any defects in materials or workmanship becoming apparent during the warranty period, by replacing or repairing any defective product or component (at its option) free of charge to the purchaser in respect of replacement parts or labour. Any defective product or component must be notified and where practicable, returned at the purchaser's expense to the Supplier immediately upon discovery of the alleged defect and no attempt made on the part of the purchaser to repair it.
  - b. EXCEPTIONS, EXCLUSIONS AND LIMITATIONS TO WARRANTY. The product and/or its components must be fitted/ assembled and loaded in accordance with the Supplier's written instructions and any requirements set out in the car's owner manual. This warranty does not cover defects, loss or damage resulting from circumstances beyond the Supplier's control including, but not limited to misuse, overloading, or failure to assemble and/or fit the product or component in accordance with the Supplier's written instructions. Nor does the warranty cover defects, loss or damage resulting from accidents, unlawful use of the vehicle or defects/inconsistencies in the vehicle on which the product or component is fitted. Liability for direct, indirect, special, punitive, incidental, exemplary, contractual or consequential damage or loss arising from defects, faulty materials or design omissions or negligence or workmanship in the product or its components is hereby expressly excluded subject to the following. Certain Commonwealth legislation, including the Competition and Consumer Act 2010 (Cth), and other State and Territorial legislation confers upon purchasers rights which cannot be excluded from or be restricted or modified by contract. Any conditions, guarantees and/or warranties implied by law and incapable of exclusion are deemed to be expressly incorporated herein. Nothing herein contained is intended nor shall be permitted to be inconsistent with any such conditions, guarantees and/or warranties. To the extent permitted by legislation all conditions, guarantees and/or warranties such as implied warranties which are capable of exclusion are hereby expressly excluded and negated.

**ADDITIONAL INFORMATION ( AUSTRALIA )**

This information should be read in conjunction with clauses (a) and (b).

**IMPORTANT LEGAL NOTICE**

Our goods come with guarantees that cannot be excluded under the Australian Consumer Law. You are entitled to a replacement or refund for a major failure and for compensation for any other reasonably foreseeable loss or damage. You are also entitled to have the goods repaired or replaced if the goods fail to be of acceptable quality and the failure does not amount to a major failure.

This warranty does not change or take away your rights under the Australian Consumer Law. Your right to claim under this policy for the benefits covered is in addition to other rights and remedies you have under the law in relation to the product.

Where you become aware of defects in materials or of workmanship, and wish to make a claim under this warranty you must do the following for the warranty to be honoured by your Whispbar dealer or Yakima Australia Pty Ltd ABN 58 154 440 221 (Yakima):

1. Make a claim as soon as practicable by contacting the Whispbar dealer from whom you purchased the product, who will give you instructions on how to proceed.
2. If you are unable to contact the Whispbar dealer, or the dealer is not able to remedy the defect, you should contact Yakima as soon as practicable at:  
 Call: 0800 4776 722 (NZ) or 1800 143 548 (AU)  
 Email: warranty@yakima.co.nz or warranty@yakima.com.au

Alternately, you can write to Yakima at 17 Hinkler Court, Brendale QLD Australia 4500 in order to make a claim under your warranty.

3. Upon contacting Yakima directly, you should explain as fully as possible the defect. A Yakima representative will provide you with appropriate instructions for returning the product together with a copy of the original purchase invoice or receipt to Yakima.
4. The costs and expenses associated with making a claim under your warranty including the costs of complying with those instructions and of returning the product to Yakima or the Whispbar dealer will be borne by you.

Following receipt of the product and purchase invoice or receipt, Yakima or the Whispbar dealer must inspect the product to determine whether the claim falls within the warranty. If:

- 4.1 the claim falls within the warranty, Yakima will remedy any defects in materials or workmanship becoming apparent during the warranty period, by replacing or repairing any defective product or component (at its option) free of charge to the purchaser in respect of replacement parts or labour.
- 4.2 the claim does not fall within the warranty, Yakima will return the product to you at your expense.